

Industrial Connectors Han® – Technical Characteristics

	Page
HARKIS® – part configuration/CAD library	00.05
Summary Han® – Sizes A	00.06
Summary Han® – Sizes B	00.07
How to order connectors	00.08
Hoods/housings insert protection	00.09
Summary hoods/housings	00.10
Summary locking systems	00.11
Termination technology	00.12
Electrical engineering data	00.16
Current Carrying Capacity	00.19
Cross Reference from PG thread to metric cable thread	00.21

Visit our homepage:

www.HARTING.com

Han

Han

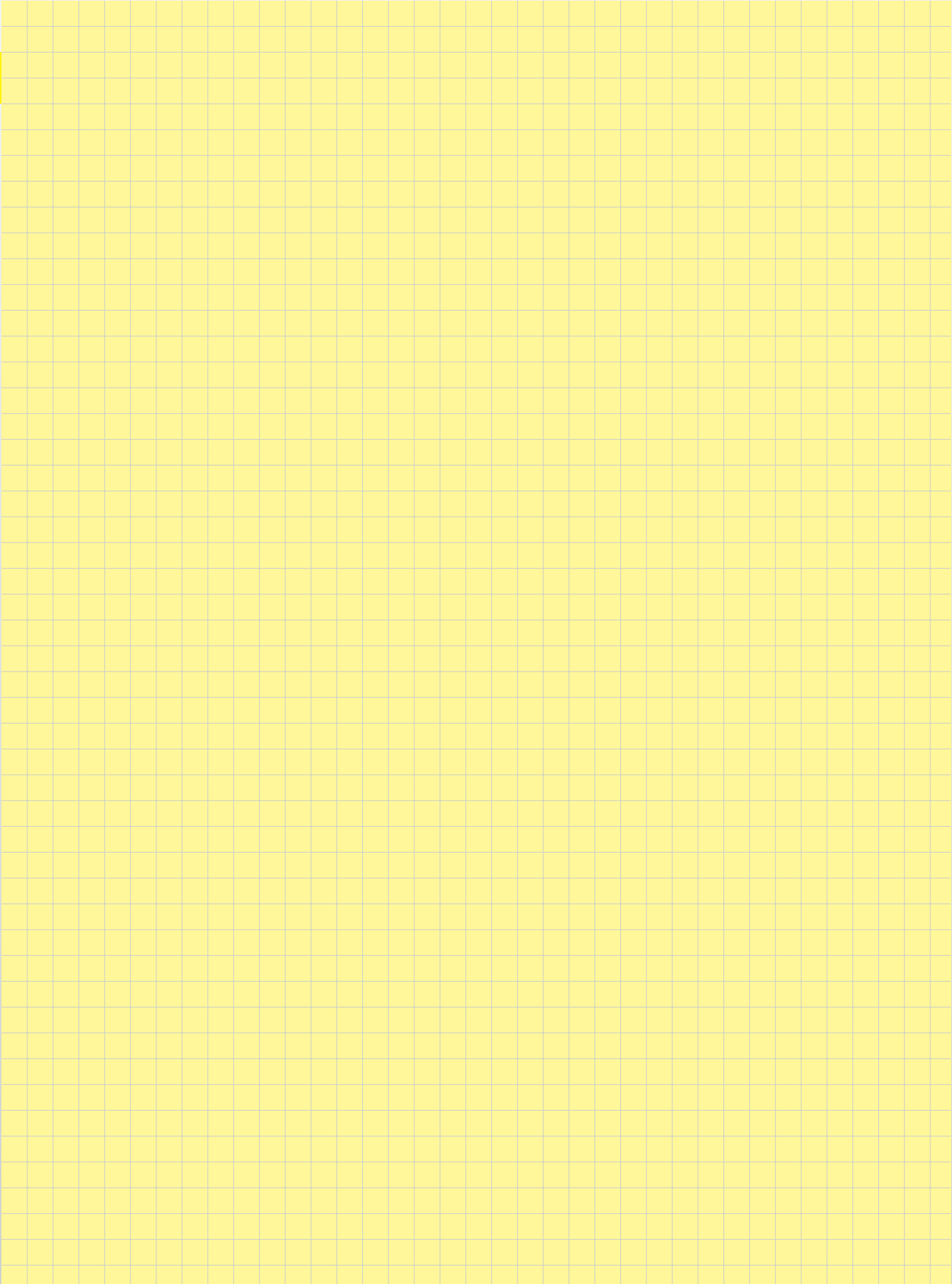



HARKIS® is the abbreviation for **HARTING-Katalog-Informationen-System** (HARTING catalogue information system).

HARKIS® is an electronic catalogue with part configuration and 3D components library. Here you can configure a connector part by part according to your demands. Afterwards you are able to send your inquiry created with the listed parts. The drawings to every single part are available in PDF-format. The parts are downloadable in 2D-format (DXF) and 3D-format (IGES, STEP). The 3D-models can be viewed with a VRML-viewer.

You can find **HARKIS®** our homepage www.HARTING.com. It is also available on CD-Rom and DVD.

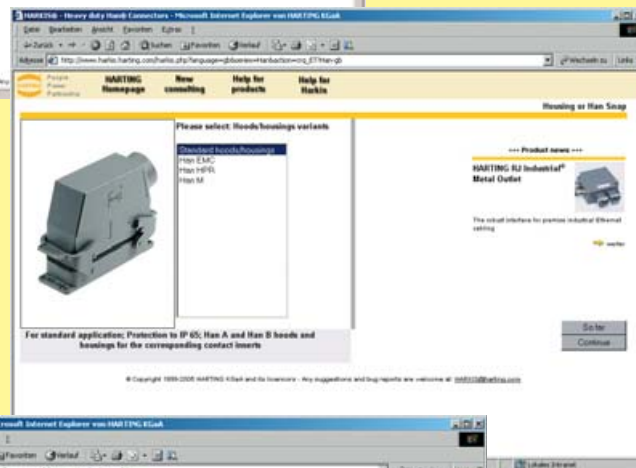

Part configuration

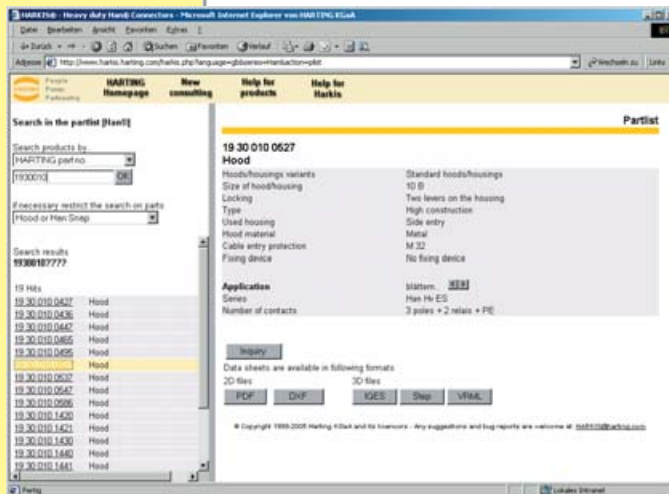

CAD library

Identification

Part number

HARKIS® CD-Rom
Basic product catalogue

98 40 000 0401

HARKIS® DVD
Basic product catalogue
2D and 3D CAD files inclusive

98 40 000 0405



This version includes the following product ranges:

- Industrial connectors Han®
- Devices and Components for Automation
- DIN 416 12 connectors / VMEB-4x
- Interface connectors
- Metric connectors

DVD

Han

Han

Size Description

A

3

Hood side-entry

Hood top-entry

230/400 V
10 A
Han® 4 A
chapter 01

230/400 V
10 A
Han® 3 A
chapter 01

50 V
10 A
Staf 6
chapter 09

250 V
10 A
Han® 7 D
chapter 02

50 V
10 A
Han® 8 D
chapter 02

230/400 V
16 A
Han® Q 5/0
chapter 13

400 V
10 A
Han® Q 7/0
chapter 13



4 + ⊕



3 + ⊕

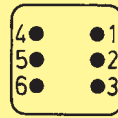

6

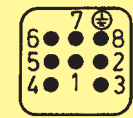

7 + ⊕

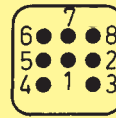

8



5 + ⊕

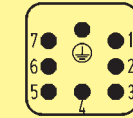

7 + ⊕

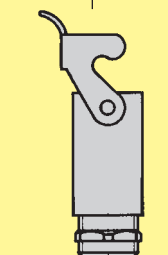

Housing
screw mounting

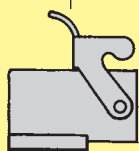

Housing
bulkhead mounting

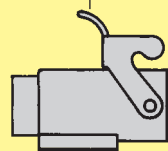

Housing
surface mounting



Housing
bulkhead mounting

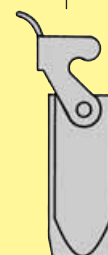

Hood
cable to cable
coupling

Hood top-entry

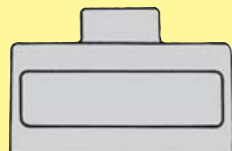

Hood side-entry



10

250 V
16 A
Han A®
chapter 01

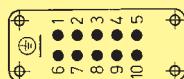

10 + ⊕

250 V
10 A
Han D®
chapter 02

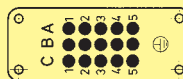

15 + ⊕

50 V
10 A
Staf®
chapter 09

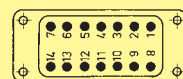

14

50 V – 1000 V
10 A – 40 A
Han-Modular®
chapter 06



1 module

16

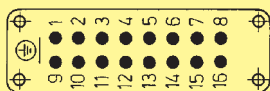

16 + ⊕

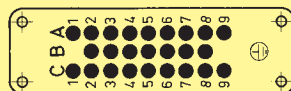

25 + ⊕

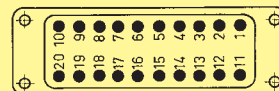

20

Housing bulkhead mounting

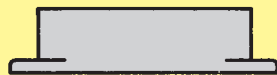

Housing surface mounting

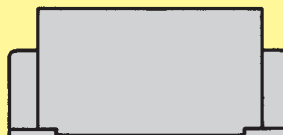

Hood cable to cable coupling



suitable for 2 inserts of size 16 A

Size Description

B

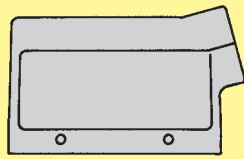

Hood side-entry

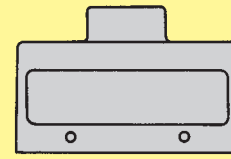

Hood top-entry

250 V 10 A Han D® chapter 02	250 V 10 A Han DD® chapter 02	500 V 16 A Han E® Han® ES chapter 03	500 V 16 A Han® EE chapter 03	400/690 V 35 A Han® HsB chapter 07	830 V 16 A Han Hv E® Han® Hv ES chapter 04	250 V – 690 V 10 A – 100 A Han-Com® chapter 05	50 V – 1000 V 5 A – 100 A Han- Modular® chapter 06
--	---	--	---	--	--	--	--

6

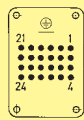

24 + \oplus

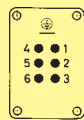

6 + \oplus



10 + \oplus

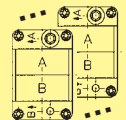

2 modules

10

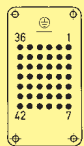

42 + \oplus

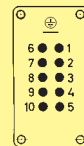

10 + \oplus

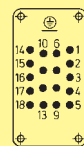

18 + \oplus

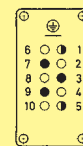

3 + \oplus

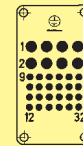

8/24 + \oplus

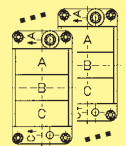

3 modules

16

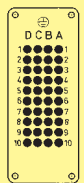

40 + \oplus

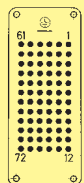

72 + \oplus

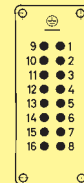

16 + \oplus

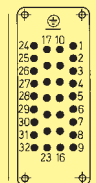

32 + \oplus

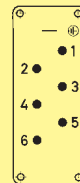

6 + \oplus

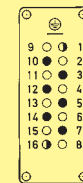

6 + \oplus

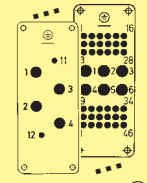

6/36 + \oplus
4/2 + \oplus

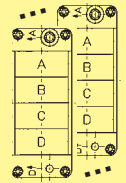

4 modules

24

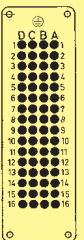

64 + \oplus

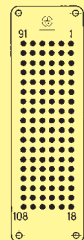

108 + \oplus

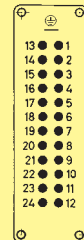

24 + \oplus

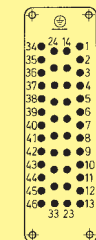

46 + \oplus

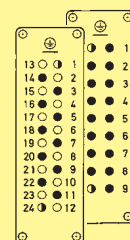

16 + \oplus
10 + \oplus

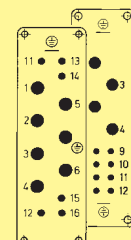

4/8 + \oplus
6/6 + \oplus

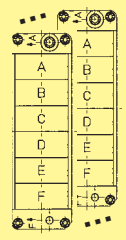

6 modules

Housing surface mounting

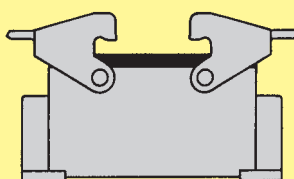

Housing bulkhead mounting



Hood cable to cable coupling

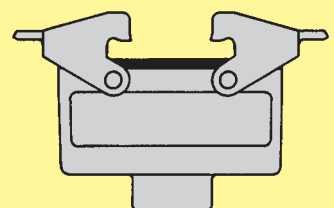

**32
48**

suitable for 2 inserts of size 16 B
suitable for 2 inserts of size 24 B

Han

00
07

For a complete connector components may be ordered from the following sub headings

Han

Cable entry protection

- Universal cable glands
- Special cable clamp with strain relief, bell mouthed cable fitting and anti-twist devices
- Cable gland with normal or multiple seal
- Extensive range of accessories

Hoods

- low or high construction
- top or side cable entry
- 1 or 2 locking levers

Male insert with

- screw terminal or crimp terminal (order contacts separately) or cage-clamp terminal

Female insert with

- screw terminal or crimp terminal (order contacts separately) or cage-clamp terminal

Housings

- Housing (bulkhead mounting) with or without thermoplastic or metal covers
- 1 or 2 locking levers
- Housing (surface mounting) low or high construction with or without thermoplastic or metal covers
- 1 or 2 locking levers
- 1 or 2 cable entries
- Hood (cable to cable) low or high construction for cable to cable connections

Accessories

- Protective covers available
- Code and guide pins for coding
- Special insert fixing screws for use without hoods and housings
- Label according to CSA-approval

Suitable hoods and housings will be found on the same page.

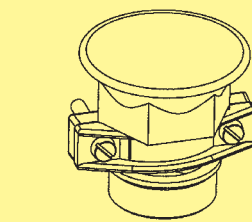

Cable clamp

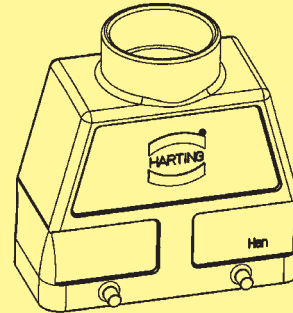

Hood



Male contacts

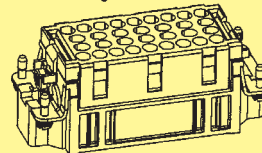

Male insert

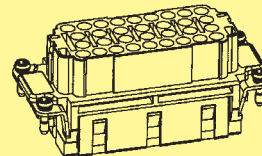

Female insert



Female contacts

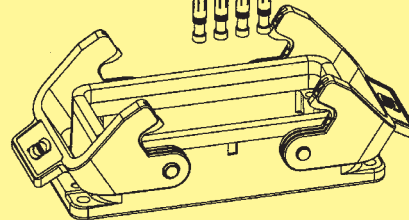

Housing





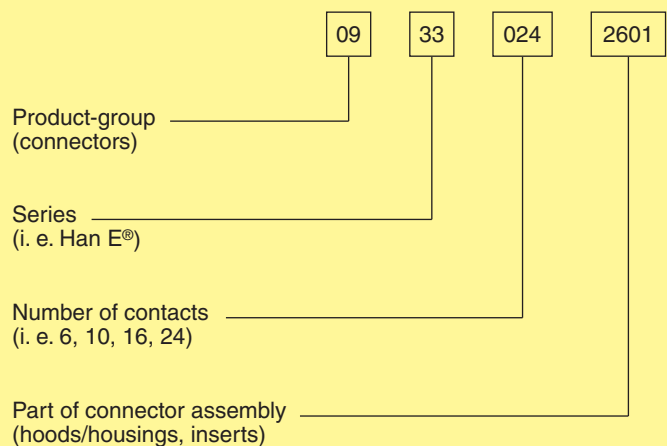







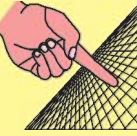

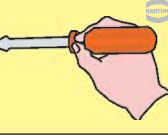
Part number explanation

Our computerized ordering system uses the following code:

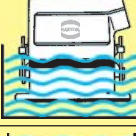

The connector's housing, sealing and locking mechanism protect the connection from external influences such as mechanical shocks, foreign bodies, humidity, dust, water or other fluids such as cleansing and cooling agents, oils, etc. The degree of protection the housing offers is explained in the IEC 60 529, DIN EN 60 529, standards that categorize enclosures according to foreign body and water protection.

The following table shows the different degrees of protection.

Code letters (International Protection)			First Index Figure (Foreign bodies protection)			Second Index Figure (Water protection)		
IP			6			5		
Index figure	Degree of protection		Index figure	Degree of protection				
0	No protection		No protection against accidental contact, no protection against solid foreign bodies	0	No protection against water	No protection against water		
1	Protection against large foreign bodies		Protection against contact with any large area by hand and against large solid foreign bodies with $\varnothing > 50$ mm	1	Drip-proof		Protection against vertical water drips	
2	Protection against medium sized foreign bodies		Protection against contact with the fingers, protection against solid foreign bodies with $\varnothing > 12$ mm	2	Drip-proof		Protection against water drips (up to a 15° angle)	
3	Protection against small solid foreign bodies		Protection against tools, wires or similar objects with $\varnothing > 2.5$ mm, protection against small foreign solid bodies with $\varnothing > 2.5$ mm	3	Spray-proof		Protection against diagonal water drips (up to a 60° angle)	
4	Protection against grain-shaped foreign bodies		As 3 however $\varnothing > 1$ mm	4	Splash-proof		Protection against splashed water from all directions	
5	Protection against injurious deposits of dust		Full protection against contact. Protection against interior injurious dust deposits	5	Hose-proof		Protection against water (out of a nozzle) from all directions	
6	Protection against ingress of dust		Total protection against contact. Protection against penetration of dust	6	Strong hose-proof		Protection against strong water (out of a nozzle) from all directions	
				7	Protected against immersion		Protected against temporary immersion	
				8	Water-tight		Protected against water pressure	

Standard Hoods/Housings

Field of application	for excellent mechanical and electrical protection in demanding environments, for example, in the automobile and mechanical engineering industries also for process and regulation control applications
Distinguishing feature	hoods/housings colour-coded grey (RAL 7037)
Material of hoods/housings	Die cast light alloy
Locking levers	Han-Easy Lock®
Cable entry protection	Optional special cable clamp for hoods with strain relief, bell mouthed cable fitting and anti-twist devices



Han® M Hoods/Housings for harsh environmental requirements

Field of application	for all applications where aggressive environmental conditions and extreme climatic atmospheres are encountered
Distinguishing feature	hoods/housings colour-coded black (RAL 9005)
Material of hoods/housings	Die cast light alloy, corrosion resistant
Locking levers	Corrosion resistant stainless steel
Cable entry protection	Special cable clamp for hoods with strain relief, bell mouthed cable fitting and anti-twist devices

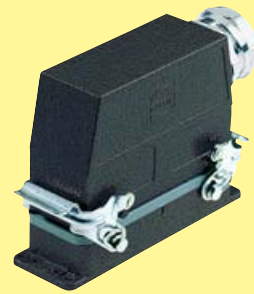

Han® EMC Hoods/Housings with high shielding efficiency

Field of application	For sensitive interconnections that have to be shielded against electrical, magnetic or electro-magnetic interferences
Distinguishing feature	Electrically conductive surface, internal seal
Material of hoods/housings	Die cast light alloy
Locking levers	Han-Easy Lock®
Cable entry protection	EMC cable clamp in order to connect the cable shielding to the hood without interruption of the shielding



Han® HPR Hoods/Housings, pressure tight

Field of application	For external electrical interconnections in vehicles, in highly demanding environments and wet areas, as well as for sensitive interconnections that have to be shielded
Distinguishing feature	hoods/housings colour-coded black, internal seal (RAL 9005)
Locking parts	Stainless steel
Material of hoods/housings	Die cast light alloy, corrosion resistant
Cable entry protection	Optional universal cable clamp for hoods with strain relief, or special cable clamp with bell mouthed cable fitting and anti-twist devices (use of adapter is necessary)



Housing with 2 levers Han-Easy Lock®

- easy operation
- high degree of pressure tightness
- reliable locking guaranteed by 4 locking points
- space saving mounting
- ideal for mounting side by side
- cable to cable connection is possible
- high seal force

Details of Han-Easy Lock® see chapter 30 and chapter 31



Housing with 1 lever Han-Easy Lock®

- easily accessible, even with side entry
- possibility to lock protective covers on the housing
- cable to cable connection is possible
- 2 locking points on the longitudinal axis



1 lever in central position

- easily accessible, even with side entry
- 2 locking points on the lateral axis
- space saving mounting
- ideal for mounting side by side
- single hand operation



Screw locking / toggle locking

- hexagon nuts tightened with spanner
- highest degree of pressure tightness
- easily accessible, also with side entry
- use of tools avoids access by unauthorized persons



Hood with 2 levers Han-Easy Lock®

- easy operation
- high degree of pressure tightness
- ideal for mating to housings with protection cover
- high seal force

Details of Han-Easy Lock® see chapter 30 and chapter 31



Screw terminal

Screw terminals meet VDE 0609 / EN 60 999. Dimensions and tightening torques for testing are shown opposite.

The relevant regulations state that in the case of

- Terminals with wire protection.
– the use of ferrules is not necessary
Series Han E®, Han® HsB, Han Hv E®, Han® K 6/12
- Terminals without wire protection.
The insulation is first stripped and then a wire ferrule must be used.
Series Han® K 4/x, Han A®, Staf®

Screw dimensions and tightening torque for screw terminals

Wire gauge (mm ²)	1,5	2,5	4	6	10	16
Screw thread	M 3	M 3	M 3,5	M 4	M 4	M 6
Test moment of torque (Nm)	0,5	0,5	0,8	1,2	1,2	1,2*
min. pull-out for stranded wire (N)	40	50	60	80	90	100

* for screws without heads (Han® K 4/8)

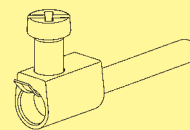

with wire protection

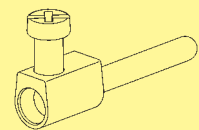

without wire protection

Axial screw terminal

This termination associates the benefits of screw and crimp terminals.

- Less space required
- Easy handling
- No special tools

The axial screw termination is suitable for fine strands wires.

Remarks on the axial screw technique

The wire gauges mentioned in the catalogue refer to geometric wire gauges of cables.

Background:

According to DIN VDE 0295 for cables and insulated wires the wire gauge will be determined by conductance (Ω/km) and maximum wire diameter. A minimum cable diameter is not specified! (Example: nominal wire gauge 95 mm² → real, geometric wire gauge 89 mm²)

Recommendation:

The use of cables with extreme geometric wire gauge deviation should be checked separately with the use of the axial screw termination.

Cage-clamp terminal

This termination method requires very little preparation of the wire and no special tools, leading to a low installed cost and a high degree of mechanical security.

- For all stranded and solid wires with a cross section 0.14 to 2.5 mm².
- Ease of termination. Conductor and screwdriver are in same plane.
- No special preparation of stripped conductor.
- The larger the conductor the higher the clamping force.
- The termination is vibration-proof.
- Guaranteed constant low resistance connection of the cage-clamp terminal.
- The cage-clamp system is internationally approved. VDE, SEV, CSA, UL, ÖVE, SEMKO, LCIE (France), Germanischer Lloyd, DET Norske Veritas

One conductor per termination

Slot for screwdriver

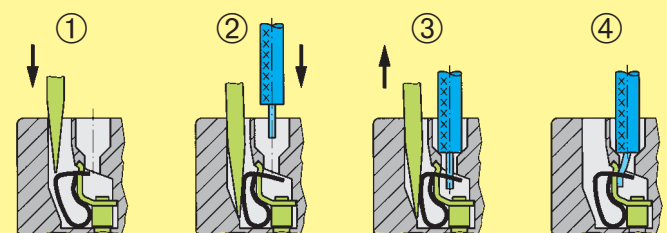
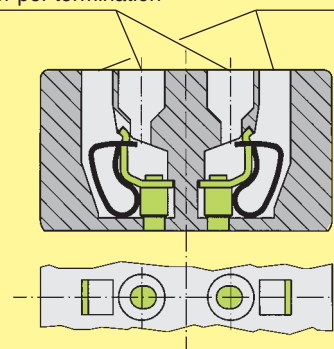

Screwdriver width: 3.0 x 0.5 mm

Crimp connection

A perfect crimp connection is gastight, therefore corrosion free and amounts to a cold weld of the parts being connected. For this reason, major features in achieving high quality crimp connections are the design of the contact crimping parts and of course the crimping tool itself. Wires to be connected must be carefully matched with the correct size of crimp contacts. If these basic requirements are met, users will be assured of highly reliable connections with low contact resistance and high resistance to corrosive attack.

The economic and technical advantages are:

- Constant contact resistance as a result of precisely repeated crimp connection quality
- Corrosion free connections as a result of cold weld action
- Pre-preparation of cable forms with crimp contacts fitted
- Optimum cost cable connection

Requirements for crimp connectors are laid down in DIN IEC 60 352-2, Amend. 2, as illustrated in the table.

Pull out force of stranded wire

The main criterion by which to judge the quality of a crimp connection is the retention force achieved by the wire conductor in the terminal section of the contact. DIN IEC 60 352, part 2, defines the extraction force in relation to the cross-section of the conductor.

When fitted using HARTING crimping tools and subject to their utilization in an approved manner, our crimp connectors comply with the required extraction forces.

Crimping tools

Crimping tools (hand operated or automatic) are carefully designed to produce with high pressure forming parts a symmetrical connection of the crimping part of the contact and the wire being connected with the minimum increase in size at the connection point. The positioner automatically locates the crimp and wire at the correct point in the tool.

A ratchet in the tool performs 2 functions:

- ① It prevents insertion of the crimp into the tool for crimping before the jaws are fully open
- ② It prevents the tool being opened before the crimping action is completed

Identical, perfectly formed, connections can be produced using this crimping system.

Crimp-cross section



HARTING crimp profile



BUCHANAN crimp profile

Tensile strength of crimped connections

Conductor cross-section		Tensile strength
mm ²	AWG	N
0.05	30	6
0.08	28	11
0.12	26	15
0.14		18
0.22	24	28
0.25		32
0.32	22	40
0.5	20	60
0.75		85
0.82	18	90
1.0		108
1.3	16	135
1.5		150
2.1	14	200
2.5		230
3.3	12	275
4.0		310
5.3	10	355
6.0		360
8.4	8	370
10.0		380

Extract from DIN IEC 60 352-2, Amend. 2, Table IV

IDC (Insulation displacement terminal)

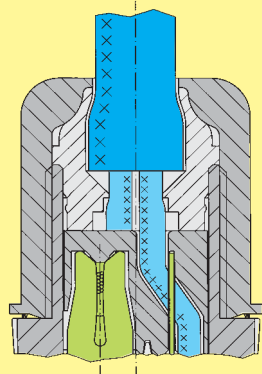

Inserts	wire gauge	
	(mm ²)	AWG
M8-S / M12-S	0.14 - 0.34	26 - 22
Circular connectors M8 / M12	0.25 - 0.5	24 (7/32) - 22
Circular connectors M12-L	0.34 - 0.75	22 - 18
M12-L Ethernet / Profibus	0.25 - 0.34	24 - 22
Panel feed through Pg 13.5 / M20	0.75 - 1.5	18 - 16
Panel feed through Pg 9	0.25 - 0.5	24 (7/32) - 22

Screw terminal

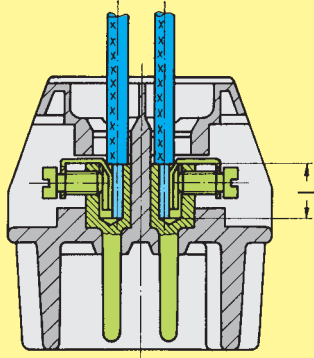

Inserts	max. wire gauge		Stripping length l (mm)
	(mm ²)	AWG	
Han [®] 3 A, Han [®] 4 A	2.5	14	4.5
Han E [®] , Han [®] K, Han A [®] , Han Hv E [®]	2.5	14	7
Han [®] HsB	6.0	10	11.5
Staf [®]	1.5	16	4
Han [®] K 4/. (80 A)	16	5	14

Axial screw terminal

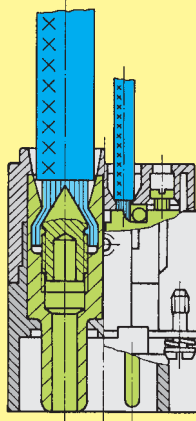

Inserts	geometrical wire gauge		Stripping length l (mm)
	(mm ²)	AWG	
Han [®] K 6/12 (40 A)	2.5 - 10	13 - 7	5 ... 9
Han [®] K 6/6 (100 A)	16 - 35	5 - 2	13 ... 14

Recommended tightening torque and size of screw driver

Size of screw	Connector type	Ø Tightening torque* [Nm]	Ø Tightening torque [lbft]	Recommended size of screw driver
M 3	Screw terminal Han [®] 3 A / 4 A / Q 5/0	0.25	0.20	0.4 x 2.5
M 3	Screw terminal Han [®] 10 A – 32 A	0.50	0.40	0.5 x 3.5 or ± size 1
M 3	Screw terminal Han E [®] , Hv E [®] fixing screws of all kinds, guiding pins and bushes	0.50	0.40	0.5 x 3.5 or ± size 1 + 2
M 4	Ground terminal Han A [®] , Han E [®] , Han D [®] , DD [®] , Ground terminal K (8/24)	1.20	0.90	0.5 x 3.5 or ± size 1 + 2
M 4	Screw terminal Han [®] HsB	1.20	0.90	0.8 x 4.5
M 5	Ground terminal Han [®] HsB HsC (K 12/2), K 4/., K 6/12	2.00	1.40	0.8 x 4.5 1.2 x 8
M 6	Screw terminal Han [®] K 4/. (80 A)	see chapter 05		0.8 x 4.5
–	Axial screw terminal Han [®] K 6/12 (40 A)			Hexagon recess 2 mm
M 8	Axial screw terminal Han [®] K 6/6 (100 A)			Hexagon recess 4 mm

Increasing the tightening torque does not improve considerably the contact resistances. The torque moments were determined when optimum mechanical, thermal and electrical circumstances were given. If the recommended figures are considerably exceeded the wire or the termination can be damaged.

* in accordance with DIN EN 60 999

Crimp terminal

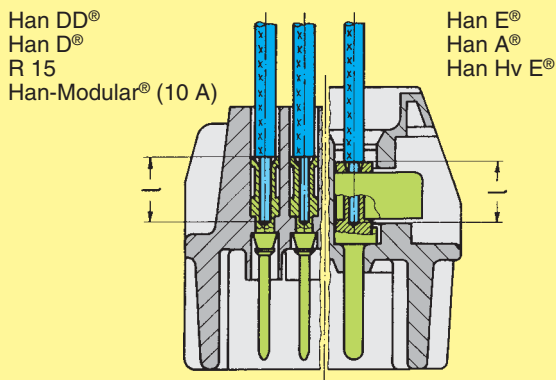

Wire gauge (mm ²)	AWG	Internal diameter Ø (mm)	Stripping length l (mm)		
			Han DD® Han D® R 15 Han-Modular® (10 A)	Han E® Han A® Han Hv E®	Han® C
0.14 ... 0.37	26 - 22	0.9	8	—	—
0.5	20	1.15	8	7.5	—
0.75	18	1.3	8	7.5	—
1	18	1.45	8	7.5	—
1.5	16	1.75	8	7.5	9
2.5	14	2.25	6	7.5	9
4	12	2.85	—	7.5	9.6
6	10	3.5	—	—	9.6

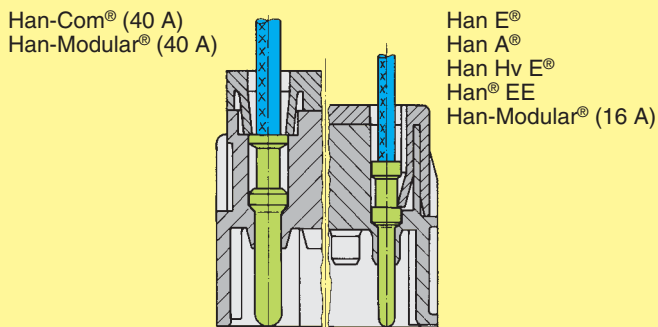

Cage-clamp terminal

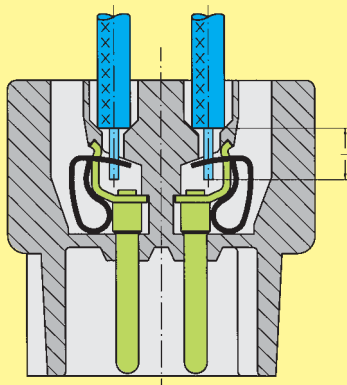

Inserts	max. wire gauge		Stripping length l (mm)
	(mm ²)	AWG	
Han® ES, Han® Hv ES	0.14 - 2.5	26 - 14	7 ... 9
Han® ESS	0.14 - 2.5	26 - 14	9 ... 11

Han

General

The choice of connectors entails more than just considering factors such as functionality, the number of contacts, current and voltage ratings. It is equally important to take account of where the connectors are to be used and the prevailing ambient conditions. This in turn means that, dependent on the conditions under which they are to be installed and pursuant to the relevant standards, different voltage and current ratings may apply for the same connectors.

The most important influencing factors and the corresponding electrical characteristics of the associated connectors are illustrated here in greater detail.

Overvoltage category

The overvoltage category is dependent on the mains voltage and the location at which the equipment is installed. It describes the maximum overvoltage resistance of a device in the event of a power supply system fault, e. g. in the event of a lightning strike.

The overvoltage category affects the dimensioning of components in that it determines the clearance air gap. Pursuant to the relevant standards, there are 4 overvoltage categories.

Equipment for industrial use, such as fall HARTING heavy duty Han connector, fall into Overvoltage Category III.

Extract from DIN VDE 0110-1 and IEC 60664-1, Para. 2.2.2.1.1

*Equipment of **overvoltage category I** is equipment for connection to circuits in which measures are taken to limit transient overvoltages to an appropriately low level.*

Note: Examples are protected electronic circuits.

*Equipment of **overvoltage category II** is energy-consuming equipment to be supplied from the fixed installation.*

Note: Examples of such equipment are appliances, portable tools and other household equipment with similar loads.

If such equipment is subjected to special requirements with regard to reliability and availability, overvoltage category III applies.

*Equipment of **overvoltage category III** is equipment in fixed installations and for cases where the reliability and the availability of the equipment is subject to special requirements.*

Note: Examples of such equipment are switches in the fixed installation and equipment for industrial use with permanent connection to the fixed installation.

*Equipment of **overvoltage category IV** is for use at the origin of the installation.*

Note: Examples of such equipment are electricity meters and primary overcurrent protection equipment.

Rated impulse voltages (Table 5 of DIN EN 61984)

Nominal voltage of the supply system (= rated insulation voltage of equipment)					Preferred values for the rated impulse voltage kV (1.2/50 μs)			
					Overvoltage category			
Voltage line to earth derived from the nominal voltage of the supply system to the a. c. voltage (r. m. s. value) or d. c. voltage	AC voltage (r. m. s. value)	AC voltage (r. m. s. value)	AC voltage (r. m. s. value, d. c. voltage)	AC voltage (r. m. s. value, d. c. voltage)	I Special protected levels	II Level for electrical equipment (household and others)	III Level for distribution supply systems	IV Input level
V	V	V	V	V				
100	66/115	66	60	–	0.5	0.8	1.5	2.5
150	120/208; 127/220	115; 120; 127	110; 120	220-110; 240-120	0.8	1.5	2.5	4
300	220/380; 230/400; 240/415; 260/440; 277/480	220; 230; 240; 260; 277	220	440-220	1.5	2.5	4	6
600	347/600; 380/660; 400/690; 415/720; 480/830	347; 380; 400; 415; 440; 480; 500; 577; 600	480	960-480	2.5	4	6	8
1000		660; 690; 720; 830; 1000	1000	–	4	6	8	12

Pollution degree

The dimensioning of operating equipment is dependent on environmental conditions. Any pollution or contamination may give rise to conductivity that, in combination with moisture, may affect the insulating properties of the surface on which it is deposited. The pollution degree influences the design of components in terms of the creepage distance.

The pollution degree is defined for exposed, unprotected insulation on the basis of environmental conditions.

HARTING heavy duty Han connectors are designed as standard for Pollution Degree 3.

Pollution degree 1

in air-conditioned or clean, dry rooms, such as computer and measuring instrument rooms, for example.

Pollution degree 2

in residential, sales and other business premises, precision engineering workshops, laboratories, testing bays, rooms used for medical purposes. As a result of occasional moisture condensation, it is to be anticipated that pollution/contamination may be temporarily conductive.

Pollution degree 3

in industrial, commercial and agricultural premises, unheated storage premises, workshops or boiler rooms, also for the electrical components of assembly or mounting equipment and machine tools.

Pollution degree 4

in outdoor or exterior areas such as equipment mounted on the roofs of locomotives or tramcars.

Extract from DIN VDE 0110-1 and IEC 60664-1, Para. 2.5.1

Pollution degree 1: No pollution or only dry, non-conductive pollution occurs. The pollution has no influence.

Pollution degree 2: Only non-conductive pollution occurs except that occasionally a temporary conductivity caused by condensation is to be expected.

Pollution degree 3: Conductive pollution occurs or dry non-conductive pollution occurs which becomes conductive due to condensation which is to be expected.

Pollution degree 4: The pollution generates persistent conductivity caused by conductive dust or by rain or snow.

Special ruling for connectors

Subject to compliance with certain preconditions, the standard for connectors permits a lower pollution degree than that which applies to the installation as a whole. This means that in a pollution degree 3 environment, connectors may be used which are electrically rated for pollution degree 2. The basis for this is contained in DIN EN 61 984, Para. 6.19.2.2.

Extract from DIN EN 61 984, Para. 6.19.2.2

For a connector with a degree of protection IP 54 or higher according to IEC 60 529 the insulating parts inside the enclosure may be dimensioned for a lower pollution degree.

This also applies to mated connectors where enclosure is ensured by the connector housing and which may only be disengaged for test and maintenance purposes.

The conditions fulfills,

- a connector which is protected to at least IP 54 as per IEC 60 529,
- a connector which is installed in a housing and which as described in the standard is disconnected for testing and maintenance purposes only,
- a connector which is installed in a housing and which when disconnected is protected by a cap or cover to at least IP 54,
- a connector located inside a switching cabinet to at least IP 54.

These conditions do not extend to connectors which when disconnected remain exposed to the industrial atmosphere for an indefinite period.

It should be noted that pollution can affect a connector from the inside of an installation outwards.

Typical applications in which to choose pollution degree 2 connectors:

- A connector serving a drive motor which is disconnected only for the purpose of replacing a defective motor, even when the plant or system otherwise calls for pollution degree 3.
- Connectors serving a machine of modular design which are disconnected for transport purposes only and enable rapid erection and reliable commissioning. In transit, protective covers or adequate packing must be provided to ensure that the connectors are not affected by pollution/contamination.
- Connectors located inside a switching cabinet to IP 54. In such cases, it is even possible to dispense with the IP 54 housings of the connectors themselves.

Specifying electrical data

Electrical data for connectors are specified as per DIN EN 61 984.

This example identifies a connector suitable for use in an un-earthed power system or earthed delta circuit (see page 00.16, Table 5 of DIN EN 61 984):

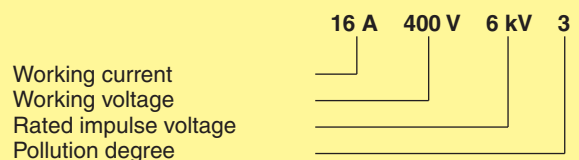

This example identifies a connector suitable exclusively for use in earthed power systems (see page 00.16, Table 5 of DIN EN 61 984):

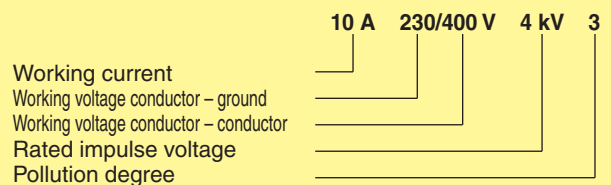

Other terms explained

Clearance air gap

The shortest distance through the air between two conductive elements (see DIN VDE 0110-1, Para. 1.3.3). The air gaps are determined by the surge voltage withstand level.

Creepage distance

Shortest distance on the surface of an insulating material between two conductive elements (see DIN VDE 0110-1, Para. 1.3.3). The creepage distances are dependent on the rated voltage, the pollution degree and the characteristics of the insulating material.

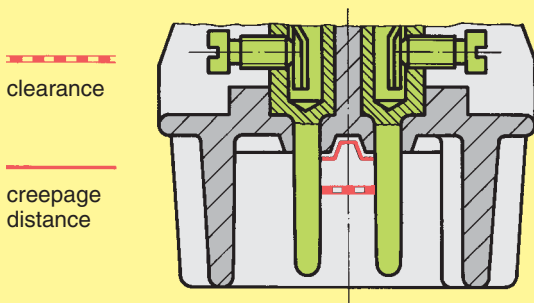

Working voltage

Fixed voltage value on which operating and performance data are based. More than one value for rated voltage or rated voltage range may be specified for the same connector.

Rated impulse voltage

The rated impulse voltage is determined on the basis of the overvoltage category and the nominal power supply voltage. This level in turn directly determines the test voltage for testing the overvoltage resistance of the connector (*Waveform voltage in 1.2/50 μ s as per IEC 60060-1*).

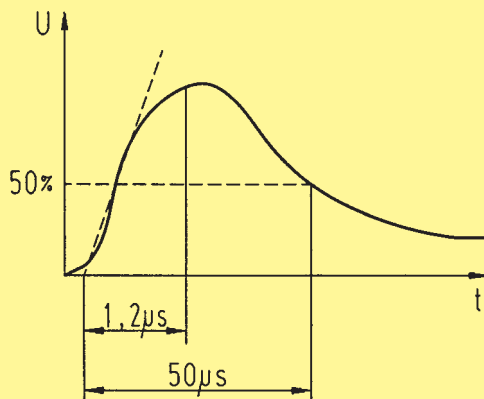

Working current

Fixed current, preferably at an ambient temperature of 40 °C, which the connector can carry on a permanent basis (without interruption), passing simultaneously through all contacts which are in turn connected to the largest possible conductors, without exceeding the upper temperature limit.

The dependence of the rated current on ambient temperature is illustrated in the respective derating diagrams.

Transient overvoltages

Short-term overvoltage lasting a few milliseconds or less, oscillatory or non-oscillatory, generally heavily damped (see DIN VDE 0110-1, Para. 1.3.7.2). An overvoltage may occur as a result of switching activities, a defect or lightning surge, or may be intentionally created as a necessary function of the equipment or component.

Power-frequency withstand voltage

A power-frequency overvoltage (50/60 Hz).

Applied for a duration of one minute when testing dielectric strength.

For test voltages in association with surge voltage withstand levels, see extract from Table 8, DIN EN 61 984.

Test voltages (Extract from Table 8, DIN EN 61 984)

Impulse withstand voltage kV (1.2/50 μ s)	RMS withstand voltage kV (50/60 Hz)
0.5	0.37
0.8	0.50
1.5	0.84
2.5	1.39
4	2.21
6	3.31
8	4.26
12	6.6

CTI (Comparative Tracking Index)

This figure gives an indication of the conductivity of insulating materials and affects the specified creepage distances. The influence of the CTI value on the creepage distance is as follows: the higher the index value, the shorter the creepage distance. The CTI is used to divide plastics into insulation groups.

Breakdown of insulation groups:

- I 600 \leq CTI
- II 400 \leq CTI < 600
- IIIa 175 \leq CTI < 400
- IIIb 100 \leq CTI < 175

Protection levels as per IEC 60 529

The protection level describes the leak-proof character of housing, e. g. for electrical equipment. It ranges from IP 00 to IP 68. HARTING heavy duty Han connectors feature a standard protection level of IP 65 (see page 00.09, Table based on DIN VDE 0470, DIN EN 60 529, IEC 60 529).

Derating diagram as per DIN IEC 60512

These diagrams are used to illustrate the maximum current carrying capacity of components. The illustration follows a curve which shows the current in relation to ambient temperature. Current carrying capacity is limited by the thermal characteristics of contacts and insulating elements which have an upper temperature limit which should not be exceeded.

Current carrying capacity

The current carrying capacity is determined in tests which are conducted on the basis of the DIN IEC 60 512 part 3. The current carrying capacity is limited by the thermal properties of materials which are used for inserts as well as by the insulating materials. These components have a limiting temperature which should not be exceeded.

The relationship between the current, the temperature rise (loss at the contact resistance) and the ambient temperature of the connector is represented by a curve. On a linear co-ordinate system the current lies on the vertical line (ordinate) and the ambient temperature on the horizontal line (abscissa) which ends at the upper limiting temperature.

In another measurement the self-heating (Δt) at different currents is determined.

At least 3 points are determined which are connected to a parabolic curve, the basic curve.

The corrected current carrying capacity curve is derived from this basic curve. The reasons for the correction are external factors that bring an additional limitation to the current carrying capacity, i.e. connectable wire gauge or an unequal dispersion of current.

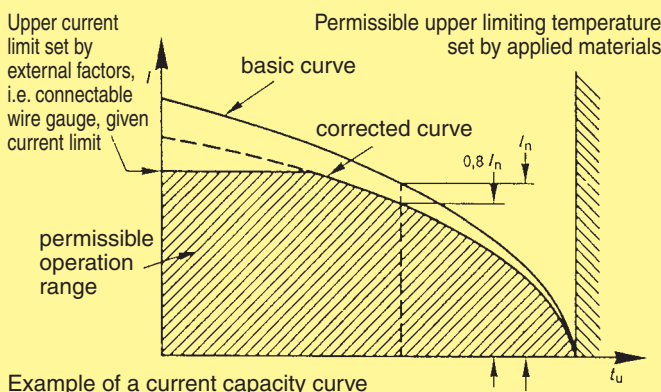

Example of a current capacity curve

Definition: The rated current is the continuous, not interrupted current a connector can take when simultaneous power on all contacts is given, without exceeding the maximum temperature.

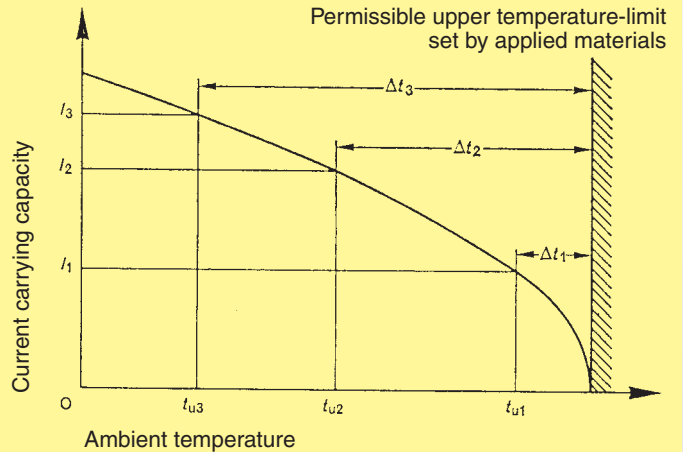

Example of a current carrying curve

Acc. to IEC 61 984 the sum of ambient temperature and the temperature rise of a connector shall not exceed the upper limiting temperature. The limiting temperature is valid for a complete connector, that means insert plus housing.

As a result the insert gives the limit for the temperature of a complete connector and thus housings as well.

In practice it is not usual to load all terminals simultaneously with the maximum current. In such a case one contact can be loaded with a higher current as permitted by the current capacity curve, if less than 20 % of the whole is loaded.

However, for these cases there are no universal rules. The limits have to be determined individually from case to case. It is recommended to proceed in accordance with the relevant rules of the DIN IEC 60 512 part 3.

Current carrying capacity of copper wires

Diameter [mm ²] of single wires in a three-phase system	0.75	1	1.5	2.5	4	6	10	16	25	35
Type of installation										
B1 Wires in protective tubes and installation conduits	7.6	10.4	13.5	18.3	25	32	44	60	77	97
B2 Cables and wires in protective tubes and installation conduits	–	9.6	12	16.5	23	29	40	53	67	83
C Cables and wires at walls	–	11.7	15.2	21	28	36	50	66	84	104
D Cables and wires on a bed	–	11.5	16.1	22	30	37	52	70	88	114
Depiction in accordance with DIN EN 60 204 for PVC-insulated copper wires in an ambient temperature of + 40 °C under permanent operating conditions. For different conditions and temperatures, installations, insulation materials or conductors the relevant corrections have to be carried out.										

Transient current carrying capacity

A transient current in circuits can be generated by switching operations such as the starting of a motor or a short circuit in a faulty installation. This can cause thermal stress at the contact. These short and very high increases cannot be dissipated quickly and therefore a local heating effect at the contact is the result. Contact design is an important feature when transient currents are encountered. HARTING contacts are machined from solid material and are therefore relatively unaffected by short overloads when compared to stamped and formed designs. For guidance please see the table below.

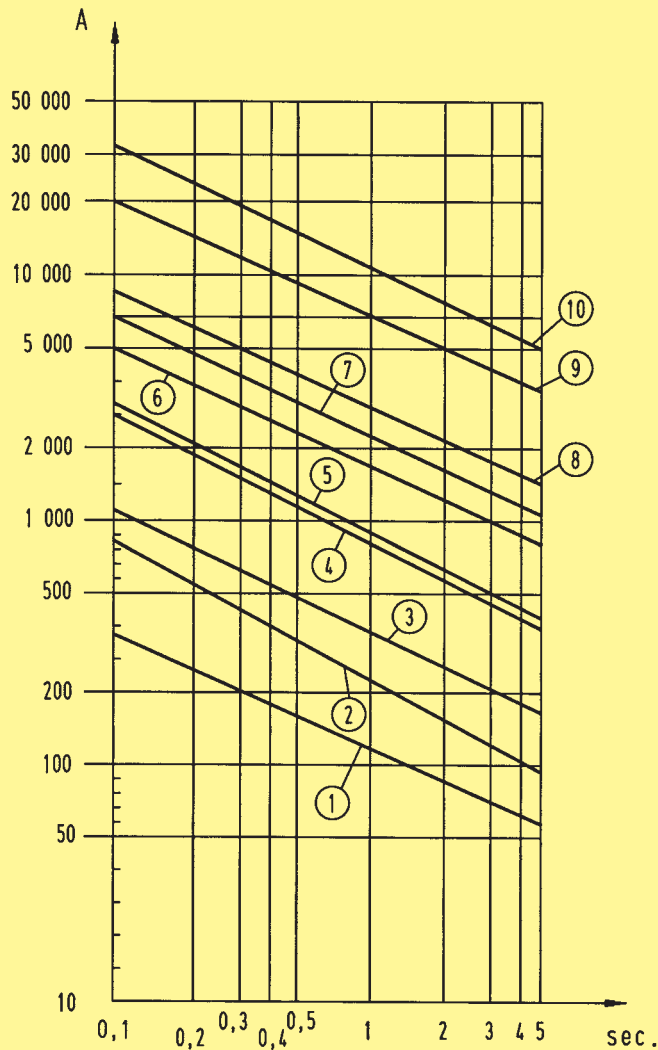

- | | |
|--------------------------------------|-----------------------|
| ① Han D® | $I_N = 10 \text{ A}$ |
| ② Han® 3 A / 4 A | $I_N = 10 \text{ A}$ |
| ③ Han A®/ Han E®, Han® ES, EE, Q 5/0 | $I_N = 16 \text{ A}$ |
| ④ Han® 6 HsB | $I_N = 35 \text{ A}$ |
| ⑤ Han® C/K axial | $I_N = 40 \text{ A}$ |
| ⑥ Han® K 4/8 | $I_N = 80 \text{ A}$ |
| ⑦ Han® K 6/6 | $I_N = 100 \text{ A}$ |
| ⑧ Han® K 3/0 | $I_N = 200 \text{ A}$ |
| ⑨ Han® HC-Modular 350 | $I_N = 350 \text{ A}$ |
| ⑩ Han® HC-Modular 650 | $I_N = 650 \text{ A}$ |

Short circuit carrying capacity

Low currents and voltages

HARTING's standard contacts have a silver plated surface. This precious metal has excellent conductive properties. In the course of a contact's lifetime, the silver surface generates a black oxide layer due to its affinity to sulphur. This layer is smooth and very thin and is partly interrupted when the contacts are mated and unmated, thus guaranteeing very low contact resistances. In the case of very low currents or voltages small changes to the transmitted signal may be encountered. This is illustrated below where an artificially aged contact representing a twenty year life is compared with a new contact.

In systems where such a change to the transmitted signal could lead to faulty functions and also in extremely aggressive environments, HARTING recommend the use of gold plated contacts.

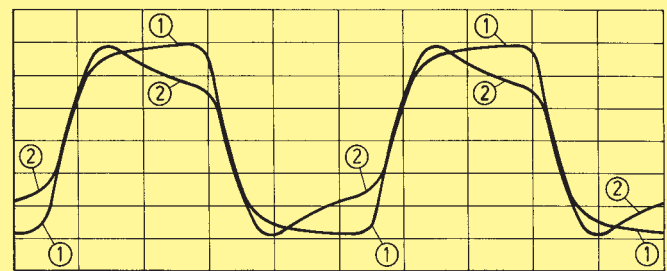

Changes to the transmitted signal after artificial ageing

- ① new contact
- ② after ageing

Below is a table derived from actual experiences.

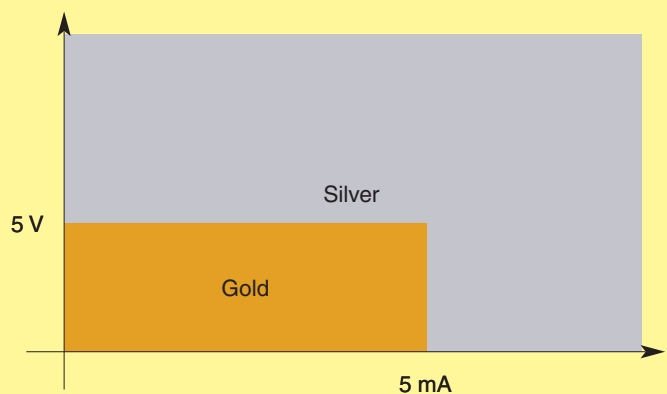

Recommendation

The reason for the new product offerings is the publication of the international DIN EN 50262 metric thread specification. The existing PG series, PG 7 to PG 48 will be, in time, replaced by the metric series M 12 to M 63.

The adoption of metric threads considerably simplifies the understanding and specification of glands as the product type description contains the thread dimension. E.g. M 20 refers to 20 mm thread diameter.

To differentiate the metric threaded hoods and housings from the previous PG versions metric types will be marked with **M**.

The Cross Reference table shows the correlation between the PG versions and the new metric types.

Please notice that the maximum cable diameter will be reduced by the new metric cable glands.

Pg	Metric
Pg 11	M 20
Pg 13.5	M 25
Pg 16	M 32
Pg 21	M 40
Pg 29	M 50
Pg 36	M 50
Pg 42	M 50

Below is shown the cable range of metric glands:

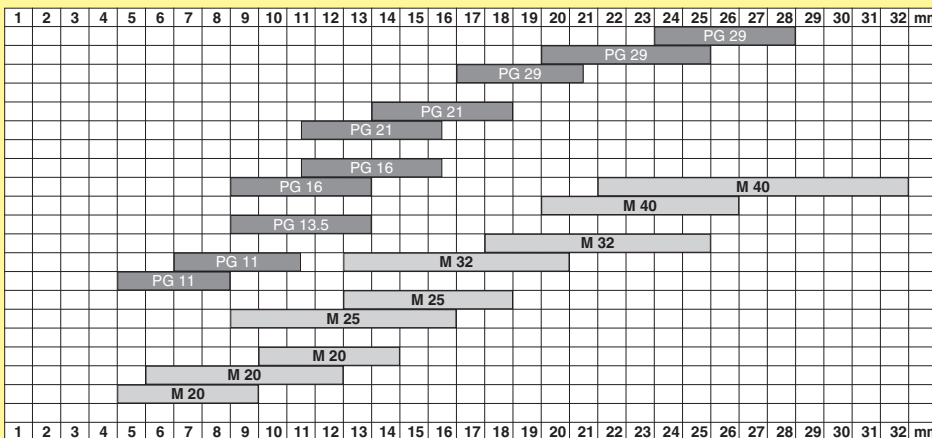

Cable

The diagram shows different cable-diameters, being dependent on wire gauges and number of conductors.

All data are averages for commercial cables.

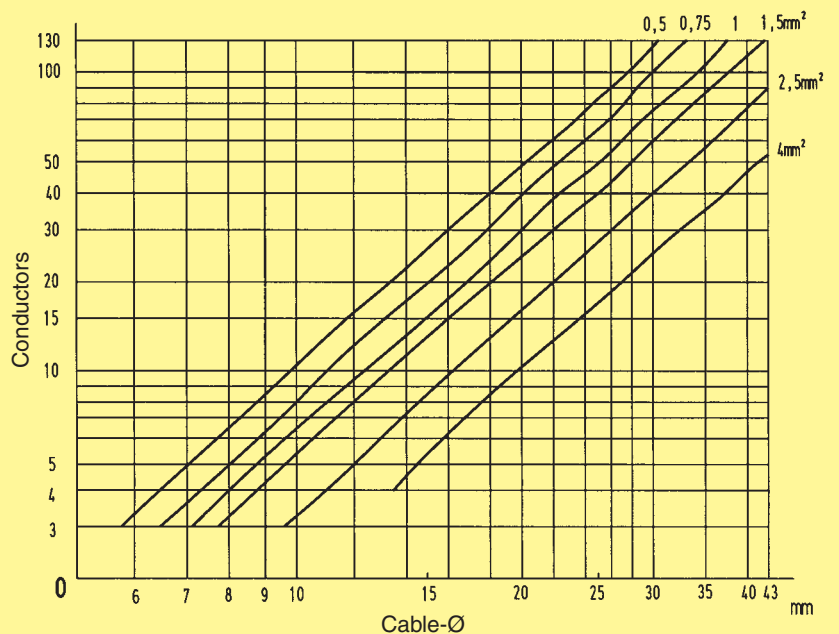

Han

This Declaration of Conformity is suitable to the European Standard EN 45 014, „General criteria for suppliers declaration of conformity“. The basis for the criteria has been found in international documentation, particularly in ISO/IEC Guide 22, 1996, „Information on manufacturers declaration of conformity with standards or other technical specifications“.

We

**HARTING KGaA
 Marienwerderstr. 3
 32339 Espelkamp**

**HARTING Electric
 GmbH & Co. KG
 Wilhelm-Harting-Str. 1
 32339 Espelkamp**

declare under our own responsibility that the product series of

Heavy Duty Han[®] Connectors

is in conformity with the following standard(s) or other normative documents:

**Connectors -
 safety requirements and tests
 IEC 61 984**

This declaration of conformity refers to the Han[®]-series

- | | | |
|-----------------------|-----------------------|--------------------------|
| Han A [®] | Han E [®] | Han [®] M |
| Han-Brid [®] | Han E [®] AV | Han-Modular [®] |
| Han-Com [®] | Han [®] EE | Han [®] Q |
| Han D [®] | Han [®] ES | |
| Han D [®] AV | Han [®] ESS | |
| Han DD [®] | Han [®] HsB | |



Our testing laboratory is accredited and monitored by the German Accreditation Body Technology/ (DATech). Reg.-Nr. DAT-P-041/94



Our quality system is certified and monitored by DQS in conformity with the standard DIN EN ISO 9001. Cert.-Nr. 2204-02

Espekamp, 2006-02-20
 Place and Date of publication

Dr. Georg Staperfeld
 Director of Corporate Technology-Services, HARTING KGaA

Espekamp, 2006-02-20
 Place and Date of publication

Dipl.-Ing. Hartmut Schwettmann
 Director of Marketing and Engineering, HARTING Electric GmbH & Co. KG