



Pushing Performance



People | Power | Partnership

HARTING

M8 / M12 Circular Connectors

Transforming customer wishes into concrete solutions



The HARTING Technology Group is skilled in the fields of electrical, electronic and optical connection, transmission and networking, as well as in manufacturing, mechatronics and software creation. The Group uses these skills to develop customized solutions and products such as connectors for energy and data transmission applications including, for example, mechanical engineering, rail technology, wind energy plants, factory automation and the telecommunications sector. In addition, HARTING also produces electro-magnetic components for the automobile industry and offers solutions in the field of Enclosures and Shop Systems.

The HARTING Group currently comprises 37 subsidiary companies and worldwide distributors employing a total of more than 3.800 staff.



HARTING Subsidiary company



HARTING Representatives



We aspire to top performance.

Connectors ensure functionality. As core elements of electrical and optical wiring, connection and infrastructure technologies, they are essential in enabling the modular construction of devices, machines and systems across a very wide range of industrial applications. Their reliability is a crucial factor guaranteeing smooth functioning in the manufacturing area, in telecommunications, applications in medical technology – in fact, connectors are at work in virtually every conceivable application area. Thanks to the consistent further development of our technologies, customers enjoy investment security and benefit from durable, long term functionality.

Always at hand, wherever our customers may be.

Increasing industrialization is creating growing markets characterized by widely diverging demands and requirements. The search for perfection, increasingly efficient processes and reliable technologies is a common factor in all sectors across the globe.

HARTING is providing these technologies – in Europe, America and Asia. The **HARTING** professionals at our international subsidiaries engage in close, partnership based interaction with our customers, right from the very early product development phases, in order to realize customer demands and requirements in the best possible manner.

Our people on location form the interface to the centrally coordinated development and production departments. In this way, our customers can rely on consistently high, superior product quality – worldwide.

Our claim: Pushing Performance.

HARTING provides more than optimally attuned components. In order to serve our customers with the best possible solutions, **HARTING** is able to contribute a great deal more and play a closely integrative role in the value creation process.

From ready assembled cables through to control racks or ready-to-go control desks: Our aim is to generate the maximum benefits for our customers – without compromise!

Quality creates reliability – and warrants trust.

The **HARTING** brand stands for superior quality and reliability – worldwide. The standards we set are the result of consistent, stringent quality management that is subject to regular certifications and audits.

EN ISO 9001, the EU Eco-Audit and ISO 14001:2004 are key elements here. We take a proactive stance to new requirements, which is why **HARTING** ranks among the first companies worldwide to have obtained the new IRIS quality certificate for rail vehicles.



HARTING technology creates added value for customers.

Technologies by HARTING are at work worldwide. HARTING's presence stands for smoothly functioning systems, powered by intelligent connectors, smart infrastructure solutions and mature network systems. In the course of many years of close, trust-based cooperation with its customers, the HARTING Technology Group has advanced to one of the worldwide leading specialists for connector technology. Extending beyond the basic functionalities demanded, we offer individual customers specific and innovative solutions. These tailored solutions deliver sustained effects, provide investment security and enable customers to achieve strong added value.

Opting for HARTING opens up an innovative, complex world of concepts and ideas.

In order to develop connectivity and network solutions serving an exceptionally wide range of connector applications and task scopes in a professional and cost optimized manner, HARTING not only commands the full array of conventional tools and basic technologies. Over and beyond these capabilities, HARTING is constantly harnessing and refining its broad base of knowledge and experience to create new solutions that ensure continuity at the same time. In securing this know-how lead, HARTING draws on a wealth of sources from both in-house research and the world of applications alike.

Salient examples of these sources of innovative knowledge include microstructure technologies, 3D design and construction technology, as well as high temperature

or ultrahigh frequency applications that are finding use in telecommunications or automation networks, in the automotive industry, or in industrial sensor and actuator applications, RFID and wireless technologies, in addition to packaging and housing made of plastics, aluminum or stainless steel.

HARTING solutions extend across technology boundaries.

Drawing on the comprehensive resources of the group's technology pool, HARTING devises practical solutions for its customers. Whether this involves industrial networks for manufacturing automation, or hybrid interface solutions for wireless telecommunication infrastructures, 3D circuit carriers with microstructures, or cable assemblies for high-temperature applications in the automotive industry – HARTING technologies offer far more than components, and represent mature, comprehensive solutions attuned to individual customer requirements and wishes. The range covers ready-to-use cable configurations, completely assembled backplanes and board system carriers, as well as fully wired and tested control panels.

In order to ensure the future proof design of RF- and EMC-compatible interface solutions, the central HARTING laboratory (certified to EN 45001) provides simulation tools, as well as experimental, testing and diagnostics facilities all the way through to scanning electron microscopes. In the selection of materials and processes, lifecycle and environmental aspects play a key role, in addition to product and process capability considerations.



HARTING knowledge is practical know-how generating synergy effects.

HARTING commands decades of experience with regard to the applications conditions of connectors in telecommunications, computer and network technologies and medical technologies, as well as industrial automation technologies, such as the mechanical engineering and plant engineering areas, in addition to the power generation industry or the transportation sector. **HARTING** is highly conversant with the specific application areas in all of these technology fields.

The key focus is on applications in every solution approach. In this context, uncompromising, superior quality is our hallmark. Every new solution found will invariably flow back into the **HARTING** technology pool, thereby enriching our resources. And every new solution we go on to create will draw on this wealth of resources in order to optimize each and every individual solution. In this way, **HARTING** is synergy in action.

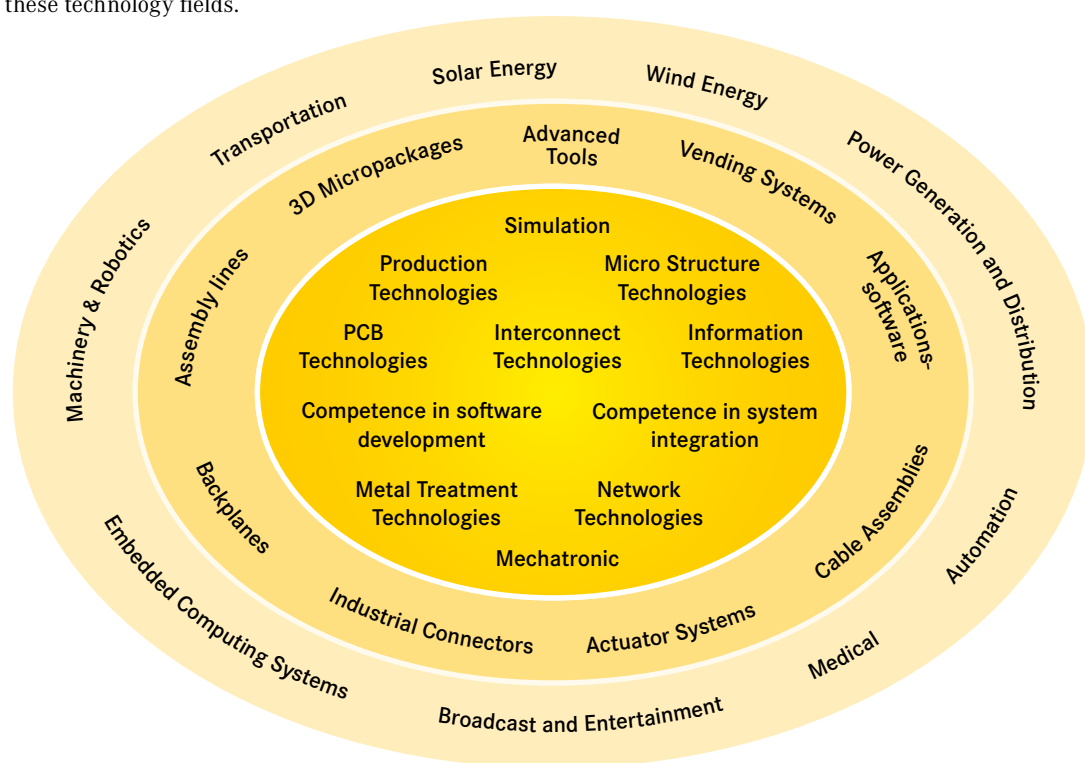

The **HARTING eCatalogue** is an electronic catalogue with a part configuration and 3D components library.

Here you can choose a connector according to your requirements. Afterwards you are able to send your inquiry directly to a HARTING sales partner.

The drawings to every single part are available in PDF-format.

The parts are downloadable in 2D-format (DXF) and 3D-format (IGES, STEP).

The 3D-models can be viewed with a VRML-viewer.

You can find the **HARTING eCatalogue** at www.HARTING.com.



Product overview

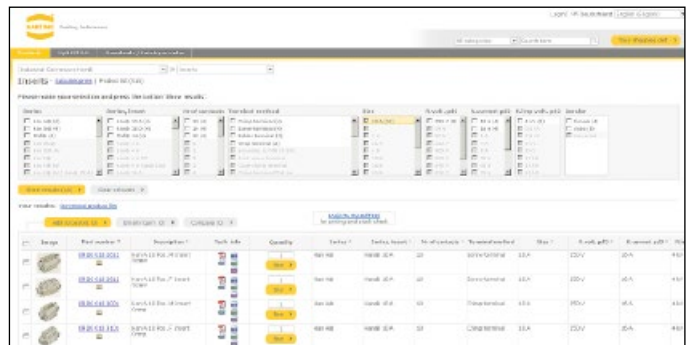

Product selection

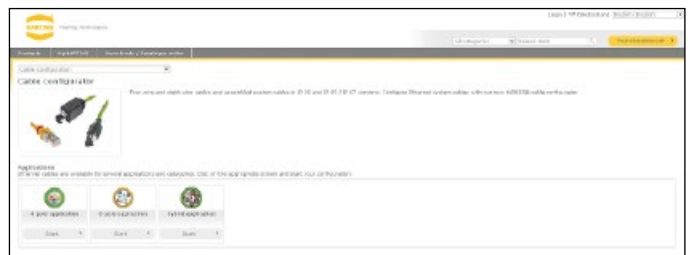

Product configuration

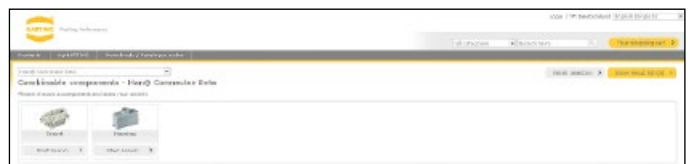

Product combination

Product samples: Fast-track delivery to your desk, free of charge

The new free express sample service in the HARTING eCatalogue allows customers to order samples immediately, easily and completely free of charge. A broad selection from the device connectivity product portfolio is now available. If a product is unavailable, the system offers alternative products with similar features that can be requested at a mouse click.

The free samples are shipped within 24 hours at no cost to you. This service enables tremendous flexibility, especially in the design phase of projects.

General information

It is the customer's responsibility to check whether the components illustrated in this catalogue also comply with different regulations from those stated in special fields of applications.

We reserve the right to modify designs or substance of content in order to improve quality, keep pace with technological advancement or meet particular requirements in production.

No part of this catalogue may be reproduced in any form (print, photocopy, microfilm or any other process) or processed, duplicated or distributed by means of electronic systems without the prior written consent of HARTING Electronics GmbH, Espelkamp. We are bound by the German version only.

Directory	Chapter	
General information	01	01
M8	02	02
M12	03	03
<i>har</i> -speed M12 data connectors	04	04
7/8" HARAX®	05	05
HARAX® panel feed-through	06	06
INOX – Solutions for extreme demands	07	07
List of part numbers	Be	Be
Addresses		

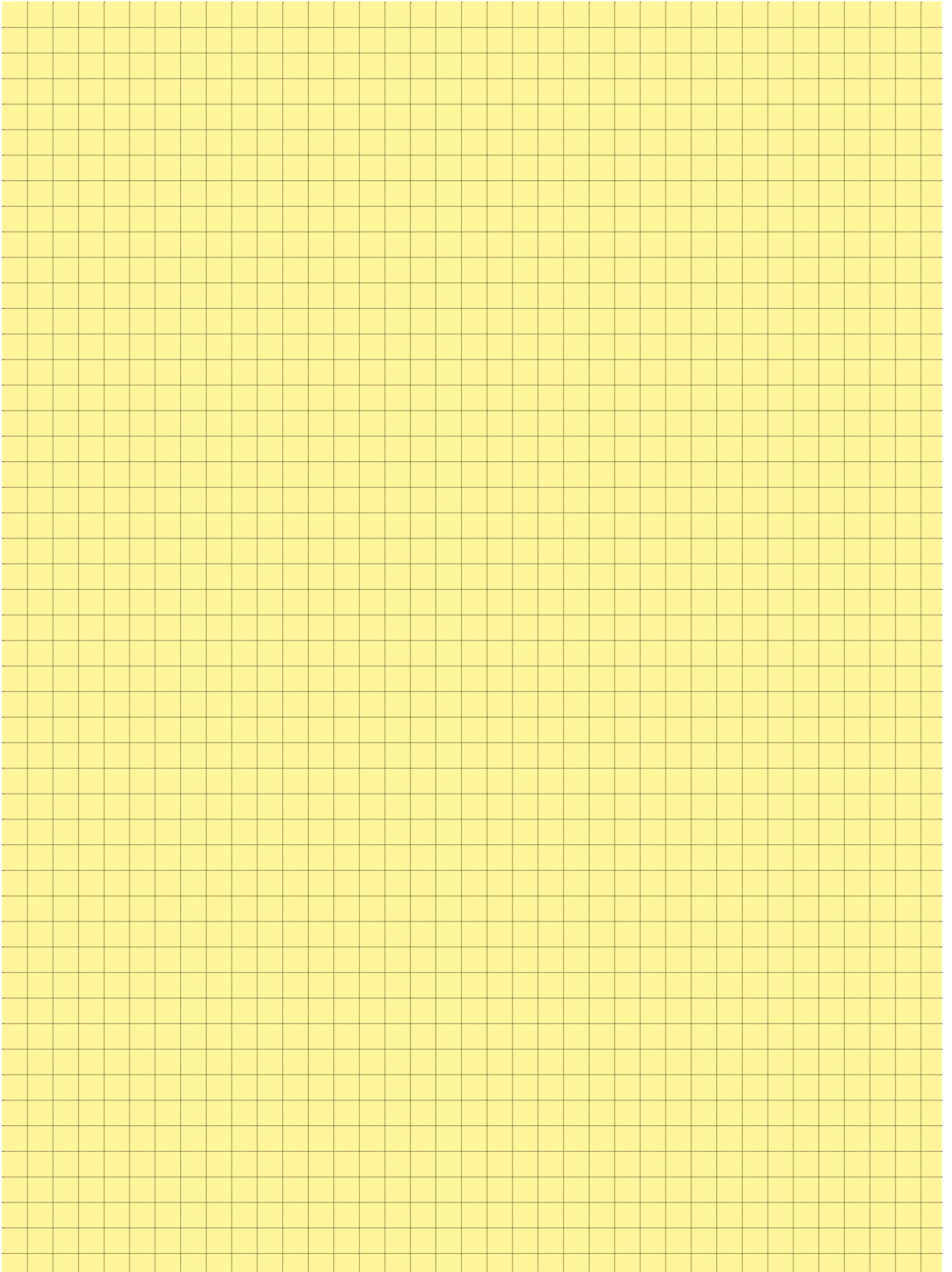

Directory

Page

1. General information

01

1.1 Circular connectors	01.02
1.2 Special series features	01.03
1.3 Termination expertise	01.04
1.4 Specifications, approvals, mating faces and pin assignments	01.05

Standardized circular connectors with M8, M12 and 7/8" thread are in widespread use in the installation of machines and systems. HARTING offers a portfolio of field-assembly angled and straight M8, M12 and 7/8" connectors which are attuned to meet all relevant automation requirements. The housings are available as plastic and as metal variant. In addition to the standard circular connectors for sensors/actuators, HARTING is offering standardized circular connectors such as the M12 variants to meet the special requirements of communication technology (Ethernet, Ethernet/IP, PROFINET, Profibus, Devicenet and CAN).

The HARTING product range comprises connectors, ready-to-use patch cables and corresponding accessories.

The easy-to-handle HARAX® quick connection technology is available for the in situ assembly of M8 and M12 connectors and

does not require the use of special tools. The portfolio of circular connectors is rounded off by the *har-speed* M12 connector family. The *har-speed* connectors are optimized for machinery and system applications with high bandwidth as well as for the IP67 infrastructure. HARTING's comprehensive and user-friendly circular connector range enables cost-effective and quick realization of all wiring and communication tasks in automation projects.

APPLIANCE INTEGRATION:

In order to support the implementation of appliances with degree of protection IP65 / IP67, HARTING offers panel feed-through devices with ready-to use patch cables and female contact modules for direct mounting on PCBs.



QUICK CONNECTION WITH HARAX®:

The HARTING HARAX® quick connection technology is an ideal solution for the in situ assembly of M8/M12 connectors. Users only have to strip the cable insulation, insert the conductors, and screw the connector together in order to produce a gas-proof and vibration resistant connection. HARAX® is a universal technology deployed in diverse connector series to wire data, signal and power lines and represents the current standard connection for Fieldbus and Fast Ethernet.



ASSEMBLED SYSTEM CABLES:

HARTING offers a comprehensive range of ready-to-use M8/M12 system cables for the quick wiring of sensors and actuators. HARTING also offers ready-to-use and tested system cables for special Ethernet communication such as PROFINET and Ethernet/IP. HARTING also provides custom patch cables which are also available as overmoulded versions. The range of solutions comprises shielded and non-shielded cables with diverse structures, as required in drag chain applications, for example.



M12 FEMALE SOCKETS FOR PCB MOUNTING:

Straight and angled contact inserts are available for direct soldering on PCBs. HARTING has developed special shielded contact inserts category 5 to ISO/IEC 11801 for Ethernet technology which meet the stringent requirements for railway applications.





WIRE TERMINATION EXPERTISE

1. IDC INSULATION DISPLACEMENT TERMINALS

IDC (insulation displacement contact) technology facilitates the simple and safe termination of solid and flexible conductors. With IDC technology, a blade cuts through the wire insulation and produces an elastic termination in a single pass. This gas-proof connection provides maximum safety even for the lowest currents and voltages. *HARAX*[®] Fast termination technology is a special feature offered by HARTING which combines the insulation displacement connector with a wire guide element for conveniently producing on-site field installation without special tools. Technical requirements for IDC technology are standardized in IEC 60352-3.

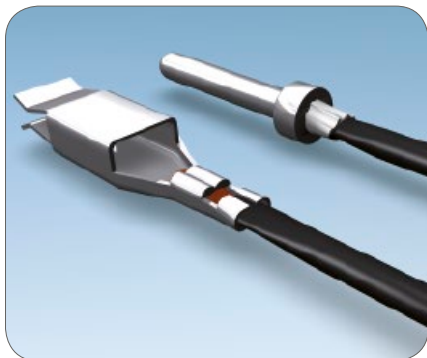

2. CRIMP TERMINALS

Gas-proof and the miniaturized contact technology are synonymous with crimp technology. The flexible conductor is inserted into the crimp contact and is retained by controlled deformation. This technology is similar to a cold welding process and provides maximum aging resistance and mechanical resistance to shock and vibration. Crimp machines facilitate the efficient, streamlined production of system cable assemblies, and crimp technology can also be deployed for field assemblies using the corresponding hand crimp tools. The technical requirements for crimp technology are standardized in IEC 60352-2.

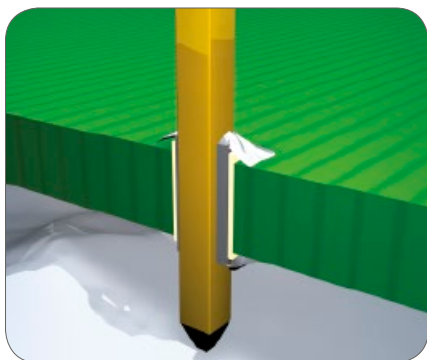

PCB TERMINATION EXPERTISE

7. THT SOLDERING TECHNOLOGY

Proven over decades, standard soldering technologies deliver maximum stability and process reliability.

The soldering pins of the connectors are inserted into the through-plated PCB holes and can then be soldered simultaneously with other components in a wave soldering process.

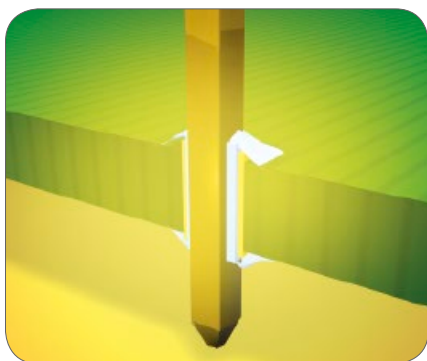

8. SMC SOLDERING TECHNOLOGY

The connector is inserted into through-plated PCB holes similar to standard component assembly for processing with SMC (Surface Mount Compatible) soldering technology. Insertion of these SMT components can be automated by means of Pick & Place assembly in preparation for a reflow soldering process together with the surface-mounted component.

This connection technology is characterized by high mechanical strength and is facilitated by a design that is specially adapted to the reflow soldering process (high-temperature materials).

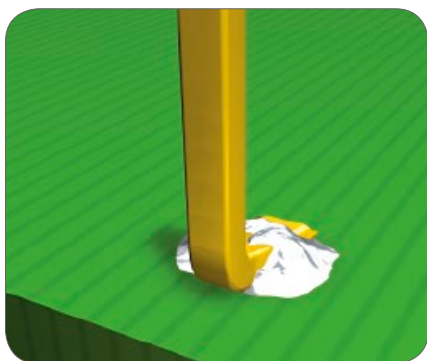

9. SMT SOLDERING TECHNOLOGY

By contrast to through-plated assembly, the SMT (Surface Mounted Technology) connectors are soldered directly onto the PCB surface by means of soldering pads.

This process represents a uniform connection technology for PCB assembly and offers the advantage of SMT connectors that do not require separate wave soldering.

Specifications

IEC 60 352-4, IEC 61076-2-104, IEC 61076-2-101, IEC 61076-2-109,



M8 circular connectors, mating face acc. to IEC 61076-2-104

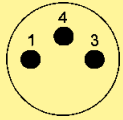

Male, 3 poles

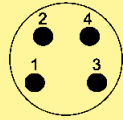

Male, 4 poles

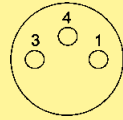

Female, 3 poles

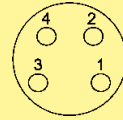

Female, 4 poles

M12 circular connectors, mating face acc. to IEC 61076-2-101

A-coding

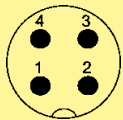

Male, 4 poles

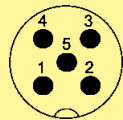

Male, 5 poles

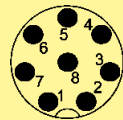

Male, 8 poles

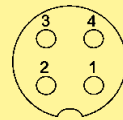

Female, 4 poles

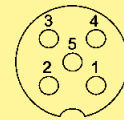

Female, 5 poles

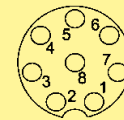

Female, 8 poles

B-coding

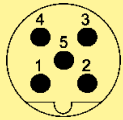

Male, 5 poles

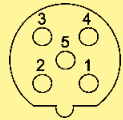

Female, 5 poles

D-coding

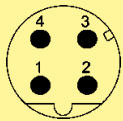

Male, 4 poles

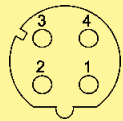

Female, 4 poles

X-coding, mating face acc. to IEC 61076-2-109

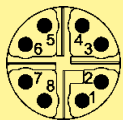

Male, 8 poles

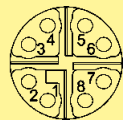

Female, 8 poles

7/8"

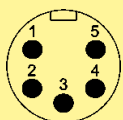

Male, 5 poles

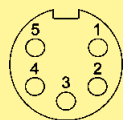

Female, 5 poles

X-coding, mating face acc. to IEC 61076-2-109

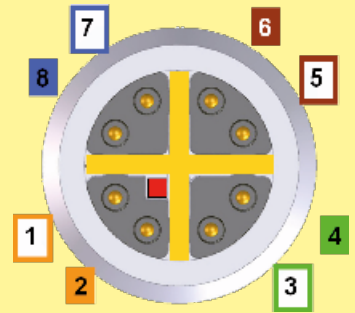

8 poles pin assignment

Signals		Pin assignment			Cable		
1/10Gbit	10/100 Mbit	RJ45	M12 D-coded	M12 X-coded	4-wire	568A	568B
BI_DA+	TxData+	1	1	1	yellow	white/green	white/orange
BI_DA-	TxData-	2	3	2	orange	green	orange
BI_DB+	RxData+	3	2	3	white	white/orange	white/green
BI_DC+	-	4	-	8		blue	blue
BI_DC-	-	5	-	7		white/blue	white/blue
BI_DB-	RxData-	6	4	4	blue	orange	green
BI_DD+	-	7	-	5		white/brown	white/brown
BI_DD-	-	8	-	6		brown	brown

Adapter M12/RJ45

4 poles pin assignment

10/100 Mbit	RJ45	M12 D-coded	4-wire
TxData+	1	1	yellow
TxData-	2	3	orange
RxData+	3	2	white
RxData-	6	4	blue

Stromlaufplan
circuit diagram

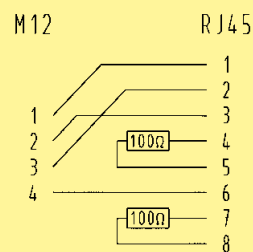

Adapter M12/RJ45

8 poles pin assignment

M12	RJ45
1	1
2	2
3	3
4	6
5	7
6	8
7	5
8	4

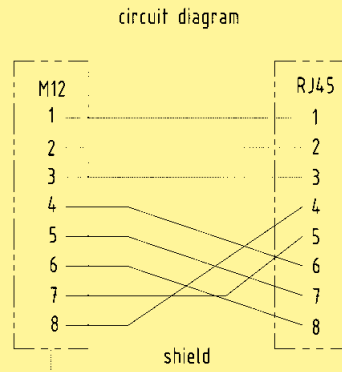

01

Gender changer

4 poles



schematic diagram

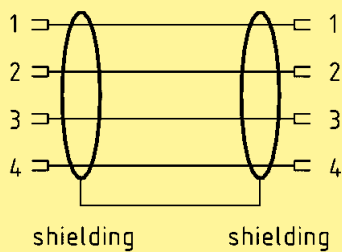

8 poles



schematic diagram

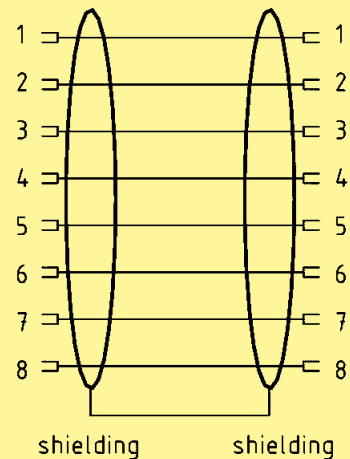

01

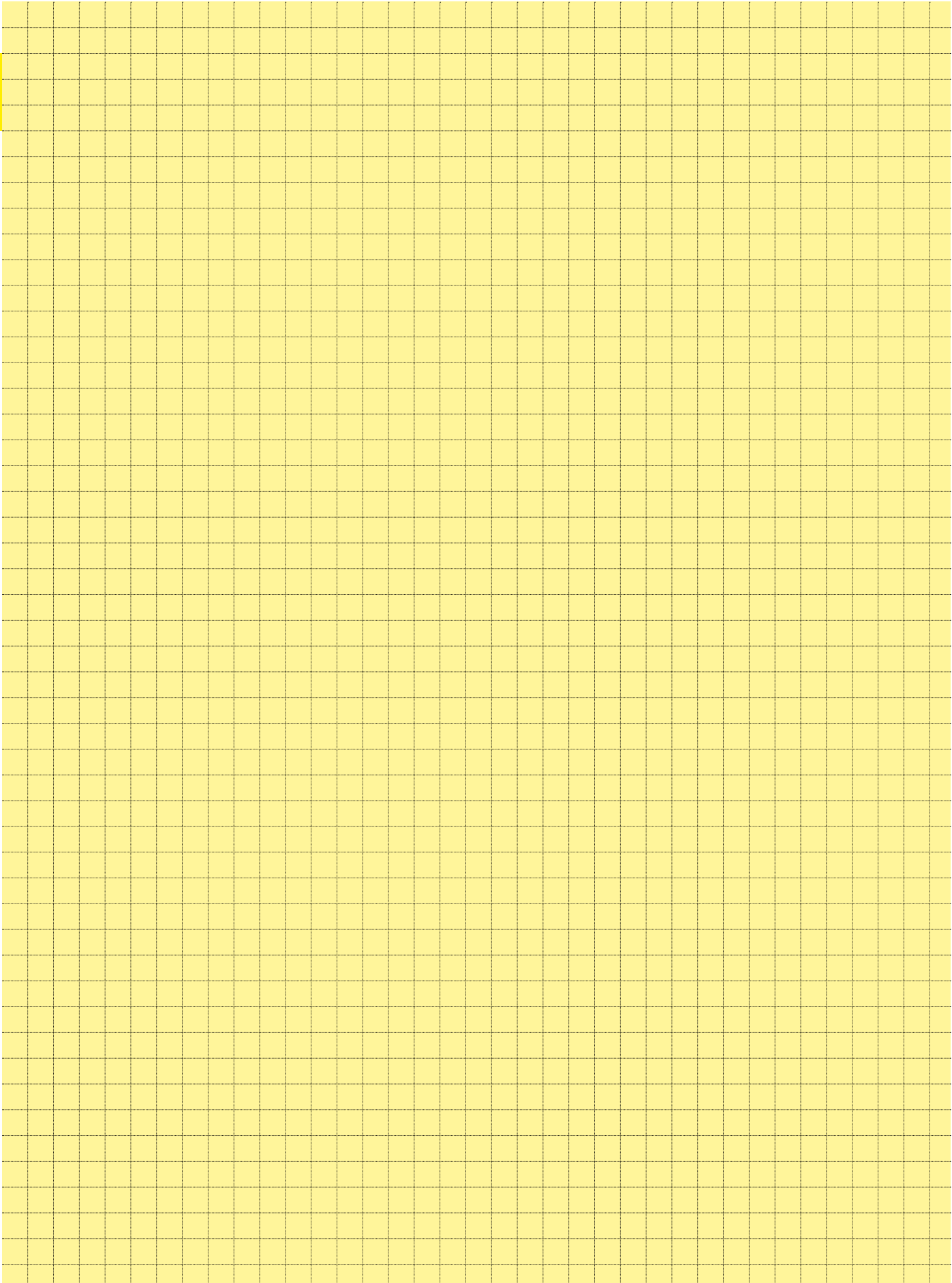

Directory

Page

2. **M8**

2.1 A-coded – Solutions for actor and sensor applications

o Technical characteristics	02.02
■ Cable connectors	
• HARAX® M8-XS	02.05
• HARAX® M8-S	02.06
• System cables	02.08
o Accessories	02.12

M8 HARAX[®] cable connector



Specifications IEC 60 352-4

Approval 

Mating face

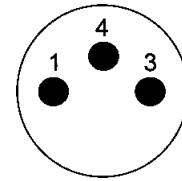

A-coding
Mating face
acc. to IEC 61 076-2-101



02

Technical characteristics M8 HARAX[®]

Type M8	HARAX [®] M8-XS	HARAX [®] M8-S
---------	--------------------------	-------------------------

General data

Conductor cross section	0.1 - 0.14 mm ² AWG 27-26	0.14 - 0.34 mm ² AWG 26-22
Diameter of individual strands	≥ 0.05 mm	≥ 0.1 mm
Conductor insulation material	PVC / PP / TPE	PVC / PP / TPE
Conductor diameter	0.6 - 1.0 mm	1.0 - 1.6 mm
Cable diameter	1.9 - 2.5 mm 2.5 - 3.5 mm	2.5 - 5.1 mm
Temperature range	-40 °C ... +85 °C	-40 °C ... +85 °C
Temperature during connection	-5 °C ... +50 °C	-5 °C ... +50 °C
Degree of protection	IP67	IP67
Mating cycles	100	100
Recommended tightening torque / Hexagonal wrench	0.4 Nm / SW 9	0.4 Nm / SW 9

Electrical characteristics

Rated current	2 A	4 A
Rated voltage	32 V	32 V
Rated impulse voltage	1.5 kV	1.5 kV
Contact resistance	10 mΩ	10 mΩ
Insulation resistance	10 ⁸ Ω	10 ⁸ Ω
Pollution degree	3	3
Overvoltage category	3	3
Isolation group	1	1

Materials

Contact material	Copper alloy	Copper alloy
Contact plating	Gold	Gold
Contact carrier material	PA	PA
Housing material	PA, zinc die-cast	PA, zinc die-cast

02
02

Technical characteristics – System cables

M8 Circular connectors, without PE

Rated voltage	max. 60 V AC/DC
Rated current / contact	max. 4 A
Locking	Screw locking M8x1, self securing
Recommended torque	0.4 Nm
Temperature range	-25 °C ... +85 °C (dependant on connected conductor)
Degree of protection	IP67
Number of wires / wire gauge	3 x 0.25 mm ²
Conductor insulation	PP (bn, bu, bk)
Arrangement of insulated strands	32 x 0.1 mm
Sheath	PUR (UL, CSA)
Outer diameter	appr. 4.2 - 5.5 mm
Bending radius	10 x outer diameter
Temperature range (working and storage)	-5 °C ... + 80 °C

Technical characteristics M8

Current carrying capacity The current carrying capacity is limited by maximum temperature of materials for inserts and contacts including terminals. The current capacity-curve is valid for continuous, not interruptet current-loaded contacts of connectors when simultaneous power on all contacts is given, without exceeding the maximum temperature.

Control and test procedures according to DIN IEC 60 512-5.

M8-XS, 3 poles 1 = Wire gauge 0.1 mm²
 M8-S, 3 poles 2 = Wire gauge 0.14 mm²

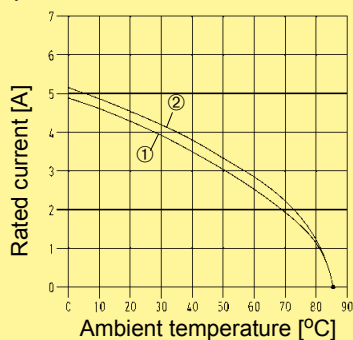

M8-S, 4 poles 1 = Wire gauge 0.25 mm²
 2 = Wire gauge 0.34 mm²

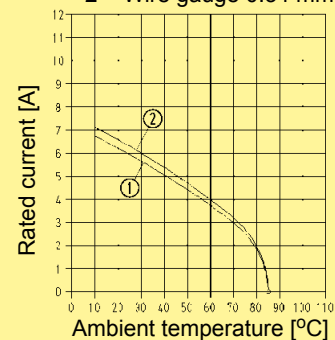

02

02
04



Mating face

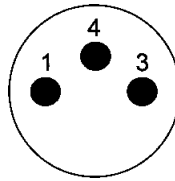

A-coding
Mating face
acc. to IEC 61076-2-101



Applications / Advantages

- Actor and sensor applications
- Unshielded versions
- HARAX® rapid termination
- Overmoulded system cables in various lengths
- Robust design, quick assembly

Identification

Part No.

Drawing

Dimensions in mm

HARAX® M8-XS



Male
straight version, 3 poles
for 0.1 - 0.14 mm²

21 02 159 1305

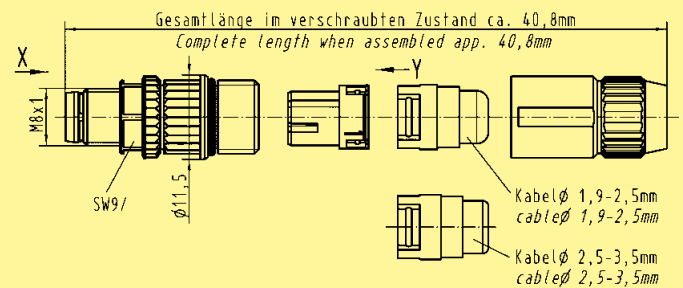



Mating face

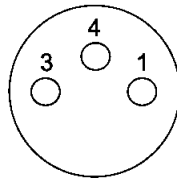

A-coding
Mating face
acc. to IEC 61076-2-101



Identification

Part No.

Drawing

Dimensions in mm

HARAX® M8-S



Female
straight version, 3 poles
for 0.14 - 0.34 mm²

21 02 151 2305

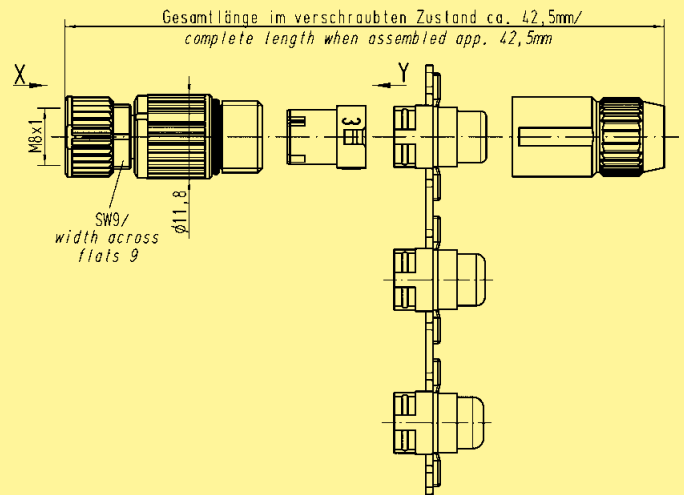

Female
straight version, 4 poles
for 0.14 - 0.34 mm²

21 02 151 2405

Mating face

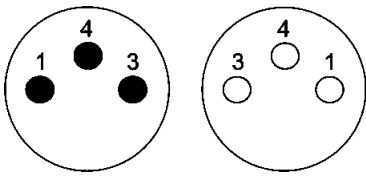

A-coding
Mating face
acc. to IEC 61076-2-101



02

Technical characteristics

M8 Circular connector, without PE

Rated voltage	max. 60 V AC/DC
Rated current/contact	max. 4 A
Locking	Screw locking M8x1, self securing
Recommended torque	0.4 Nm
Temperature range (dependant on connected conductor)	-25 °C ... +85 °C
Degree of protection	IP67
Number of wires / wire gauge	3 x 0.25 mm ²
Conductor insulation	PP (br, bl, sw)
Arrangement of insulated strands	32 x 0.1 mm
Sheath	PUR (UL, CSA)
Outer diameter	appr. 4.2 - 5.5 mm
Bending radius	10 x outer diameter
Temperature range (working and storage)	-5 °C ... + 80 °C

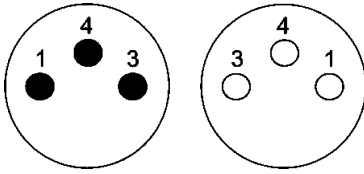

Mating face



A-coding
Mating face
acc. to IEC 61076-2-101

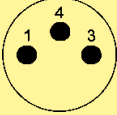
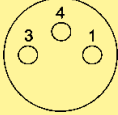
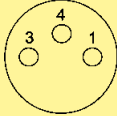
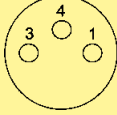

Overview system cables M8

Number of contacts		Male M8 straight		Female M8 angled	
		 Cable material PUR		 Cable material PUR	
Female M8 angled		0.3 m	21 02 454 5301	xxx	
		0.6 m	21 02 454 5302		
		1.0 m	21 02 454 5303		
		1.5 m	21 02 454 5304		
		2.0 m	21 02 454 5305		
		0.3 m	21 02 454 7301 with LED	xxx	
		0.6 m	21 02 454 7302 with LED		
		1.0 m	21 02 454 7303 with LED		
		1.5 m	21 02 454 7304 with LED		
		2.0 m	21 02 454 7305 with LED		
Open end		xxx		1.5 m	21 02 554 4301
		xxx		3.0 m	21 02 554 4302
		xxx		5.0 m	21 02 554 4303
		xxx		7.5 m	21 02 554 4304
		xxx		10.0 m	21 02 554 4305
		xxx		1.5 m	21 02 554 7301 with LED
		xxx		3.0 m	21 02 554 7302 with LED
		xxx		5.0 m	21 02 554 7303 with LED
		xxx		7.5 m	21 02 554 7304 with LED
		xxx		10.0 m	21 02 554 7305 with LED

M8 System cables



Mating face

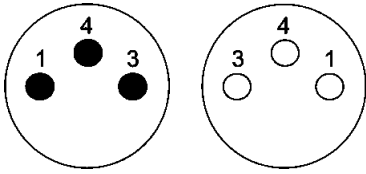

A-coding
Mating face
acc. to IEC 61076-2-101



02

Identification

Part No.

Drawing

Dimensions in mm

M8 Circular connectors
Female angled, male straight

Length: 0.3 m
0.6 m
1.0 m
1.5 m
2.0 m

21 02 454 5301
21 02 454 5302
21 02 454 5303
21 02 454 5304
21 02 454 5305

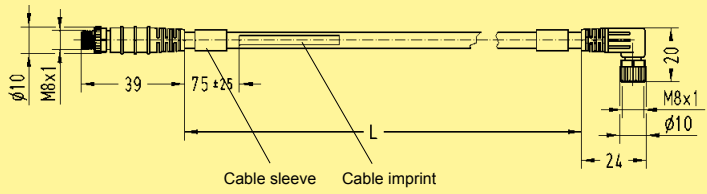

View mating side



Schematic diagram

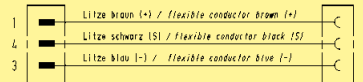

M8 Circular connectors
Female angled, with LED
Male straight

Length: 0.3 m
0.6 m
1.0 m
1.5 m
2.0 m

21 02 454 7301
21 02 454 7302
21 02 454 7303
21 02 454 7304
21 02 454 7305

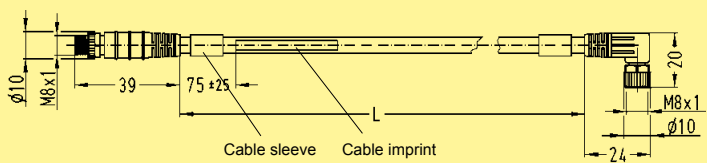

View mating side



Schematic diagram

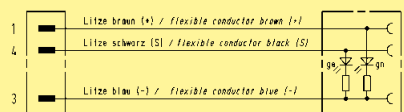

02
10

M8 System cables



Mating face

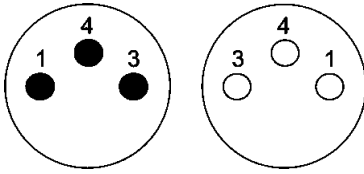

A-coding
Mating face
acc. to IEC 61076-2-101



02

Identification

Part No.

Drawing

Dimensions in mm

M8 Circular connectors

Female angled
pre-assembled on one end

Length: 1.5 m
3.0 m
5.0 m
7.5 m
10.0 m

21 02 554 4301
21 02 554 4302
21 02 554 4303
21 02 554 4304
21 02 554 4305

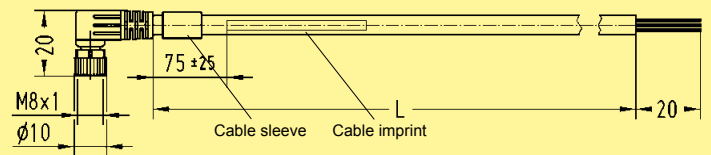

Schematic diagram

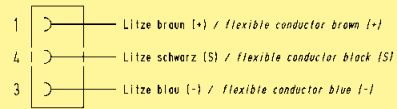

View mating side

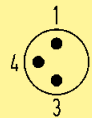

M8 Circular connectors

Female angled, with LED
pre-assembled on one end

Length: 1.5 m
3.0 m
5.0 m
7.5 m
10.0 m

21 02 554 7301
21 02 554 7302
21 02 554 7303
21 02 554 7304
21 02 554 7305

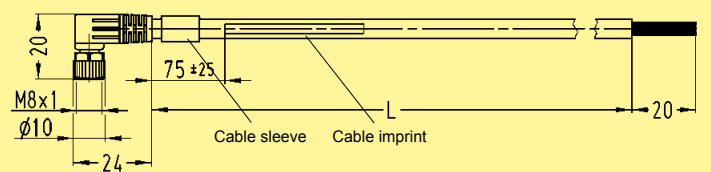

Schematic diagram

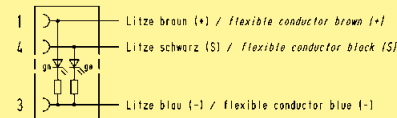

View mating side

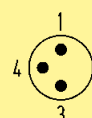

02

Identification

Part No.

Drawing

Dimensions in mm

Seal M8

for 1.9 - 2.5 mm cable Ø
for 2.5 - 3.5 mm cable Ø
for 4.2 - 5.4 mm cable Ø



21 01 010 2016
21 01 010 2008
21 01 010 2005

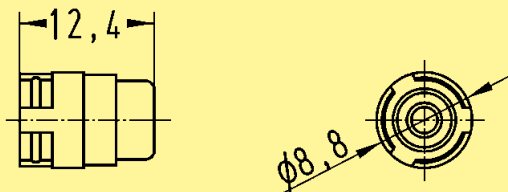

Set of seals for HARAX® M8-S

for 2.5 - 3.2 mm cable Ø
for 3.2 - 4.0 mm cable Ø
for 4.0 - 5.1 mm cable Ø



21 01 010 2013

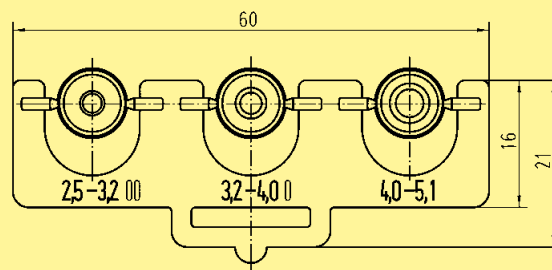

M8 dynamometric screwdriver

Tightening torque 0.4 Nm

SW 9

09 99 000 0380



02
12

Directory

Page

3. M12

3.1 A-coded – Solutions for actor and sensor applications

o Technical characteristics	03.04
■ Cable connectors	
• HARAX® M12-S	03.08
• HARAX® M12 angled	03.10
• HARAX® M12-L unshielded	03.12
• HARAX® M12-L shielded	03.14
• M12 Crimp	03.16
• System cables	03.20
■ Device connectors	
• Panel feed-through	03.26
• PCB adapter	03.32
o Accessories	03.36

3.2 B-coded – Solutions for Profibus applications

o Technical characteristics	03.40
■ Cable connectors	
• HARAX® M12 L shielded	03.42
• M12 Crimp	03.44
• System cables	03.46
■ Device connectors	
• Panel feed-through	03.50
• PCB adapter	03.56
o Accessories	03.60

3.3 D-coded – Solutions for Ethernet applications

o Technical characteristics	03.64
■ Cable connectors	
• HARAX® M12 L shielded	03.66
• M12 Crimp	03.68
• M12 preLink®	03.71
• System cables	03.73
■ Device connectors	
• Panel feed-through	03.78
• PCB adapter	03.86
o Accessories	03.91

03

03
02

Directory

Page

3.1 A-coded – Solutions for actor and sensor applications

o Technical characteristics	03.04
■ Cable connectors	
• HARAX® M12-S	03.08
• HARAX® M12 angled	03.10
• HARAX® M12-L unshielded	03.12
• HARAX® M12-L shielded	03.14
• M12 Crimp	03.16
• System cables	03.20
■ Device connectors	
• Panel feed-through	03.26
• PCB adapter	03.32
o Accessories	03.36

M12 A-coding



Specifications IEC 60 352-4

Approval 



Mating face

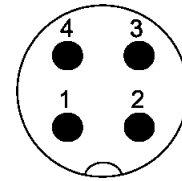

A-coding
Mating face
acc. to IEC 61 076-2-101

Technical characteristics M12 – A-coding

03

Type M12 A-coded	HARAX® M12-S	HARAX® M12 angled	HARAX® M12 L 3 poles, 4 poles
------------------	--------------	-------------------	----------------------------------

General data

Conductor cross section	0.14 - 0.34 mm ² AWG 26-22	0.25 - 0.5 mm ² AWG 24/7-20	0.34 - 0.75 mm ² AWG 22-18
Diameter of individual strands	≥ 0.1 mm	≥ 0.1 mm	≥ 0.1 mm
Conductor insulation material	PVC / PP / TPE	PVC	PVC
Conductor diameter	1.0 - 1.6 mm	1.2 - 1.6 mm	1.6 - 2.0 mm 2.0 - 2.6 mm
Cable diameter	2.9 - 4.0 mm 4.0 - 5.1 mm	4 - 5.1 mm	6 - 8 mm
Temperature range	-40 °C ... +85 °C	-40 °C ... +85 °C	-40 °C ... +85 °C
Temperature during connection	-5 °C ... +50 °C	-5 °C ... +50 °C	-5 °C ... +50 °C
Degree of protection	IP67	IP67	IP65 / IP67
Mating cycles	100	100	100
Tightening torque connector / hexagonal wrench	0.6 Nm / SW 13	0.6 Nm / SW 13	0.6 Nm / SW 17

Electrical characteristics

Rated current	4 A	4 A	6 A
Rated voltage	32 V	32 V	50 V
Rated impulse voltage	1.5 kV	1.5 kV	1.5 kV
Contact resistance	10 mΩ	10 mΩ	10 mΩ
Insulation resistance	10 ⁸ Ω	10 ⁸ Ω	10 ⁸ Ω
Pollution degree	3	3	3
Overvoltage category	3	3	3
Isolation group	1	1	1

Materials

Contact material	Brass	Brass	Brass
Contact plating	Gold	Gold	Gold
Contact carrier material	PA reinforced	PA	PA unreinforced
Housing material	PA reinforced	PA	PA unreinforced

03
04

M12 A-coding



Specifications IEC 60 352-4

Approval 



Mating face

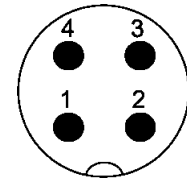

A-coding
Mating face
acc. to IEC 61076-2-101

Technical characteristics M12 – A-coding

03

Type M12 A-coded	HARAX® M12-L 5 poles	HARAX® M12 L shielded	M12 Crimp
------------------	-------------------------	--------------------------	-----------

General data

Conductor cross section	0.34 - 0.5 mm ² AWG 22-20	0.14 - 0.34 mm ² AWG 26-22	0.14 - 0.75 mm ² AWG 26-18
Diameter of individual strands	≥ 0.1 mm	≥ 0.1 mm	X
Conductor insulation material	PVC	PVC	X
Conductor diameter	1.2 - 2.0 mm	1.2 - 1.6 mm	2.0 - 2.3 mm
Cable diameter	6 - 8 mm	4.5 - 8.8 mm	4.5 - 8.8 mm
Temperature range	-40 °C ... +85 °C	-40 °C ... +85 °C	-40 °C ... +85 °C
Temperature during connection	-5 °C ... +50 °C	-5 °C ... +50 °C	-5 °C ... +50 °C
Degree of protection	IP65 / IP67	IP65 / IP67	IP67
Mating cycles	100	100	500
Tightening torque connector / hexagonal wrench	0.6 Nm / SW 17	0.6 Nm / SW 17	0.5 Nm / SW 17

Electrical characteristics

Rated current	4 A	4 A	4 A
Rated voltage	50 V	50 V	250 V
Rated impulse voltage	1.5 kV	1.5 kV	1.5 kV
Contact resistance	10 mΩ	10 mΩ	10 mΩ
Insulation resistance	10 ⁸ Ω	10 ⁸ Ω	10 ⁸ Ω
Pollution degree	3	3	3
Overvoltage category	3	3	3
Isolation group	1	1	1

Materials

Contact material	Brass	Brass	Brass
Contact plating	Gold	Gold	Gold
Contact carrier material	PA unreinforced	PA unreinforced	PA
Housing material	PA unreinforced	PA unreinforced	PA

Technical characteristics M12 – A-coding

Current carrying capacity The current carrying capacity is limited by maximum temperature of materials for inserts and contacts including terminals. The current capacity-curve is valid for continuous, not interrupted current-loaded contacts of connectors when simultaneous power on all contacts is given, without exceeding the maximum temperature.

Control and test procedures according to DIN IEC 60 512-5.

03

M12-S, 4 poles 1 = Wire gauge 0.25 mm²
2 = Wire gauge 0.34 mm²

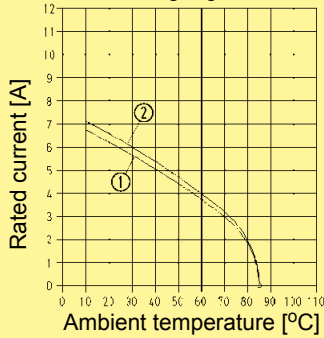

M12-L 3 poles, 4 poles 1 = Wire gauge 0.34 mm²
2 = Wire gauge 0.75 mm²

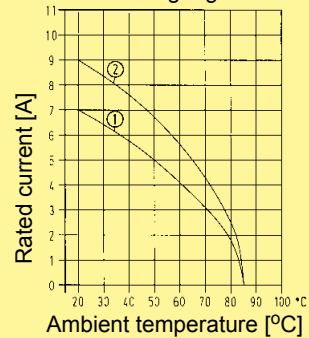

M12, 4 poles, angled 1 = Wire gauge 0.25 mm²
2 = Wire gauge 0.5 mm²

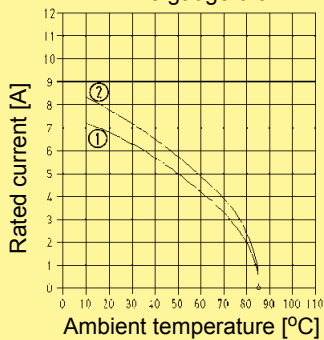

M12L, 5 poles 1 = Wire gauge 0.25 mm²
2 = Wire gauge 0.34 mm²

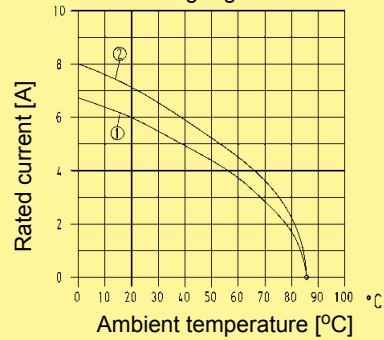

M12, Crimp 1 = Wire gauge 0.34 mm² /
0.5 mm²

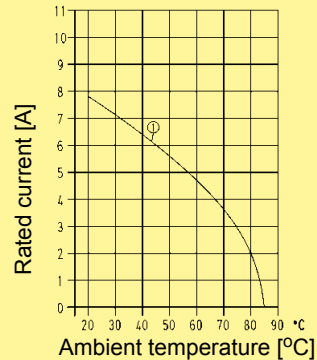

03
06

Technical characteristics M12 – A-coding, PCB adapter

M12, A-coding, straight, male, 4 poles
Wire gauge 0.5 mm²

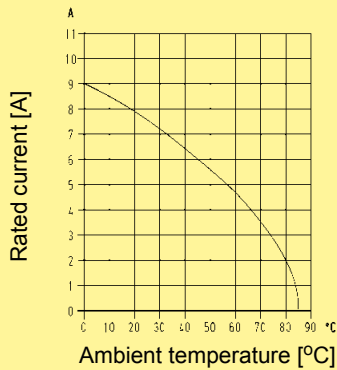

M12, A-coding, straight, female, 4 poles
Wire gauge 0.75 mm²

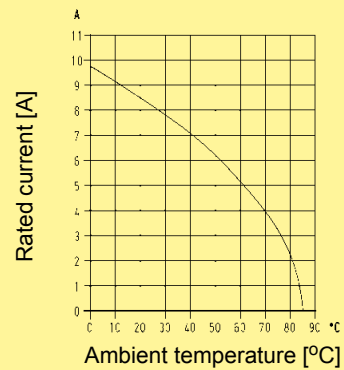

M12, A-coding, straight, female, 5 poles
Wire gauge 0.5 mm²

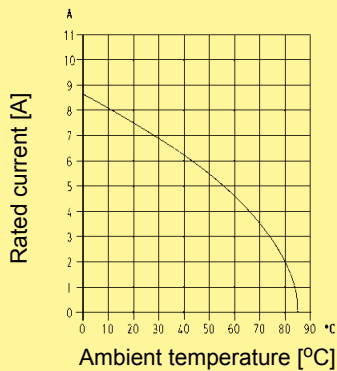

M12, A-coding, straight, male, 5 poles
Wire gauge 0.5 mm²

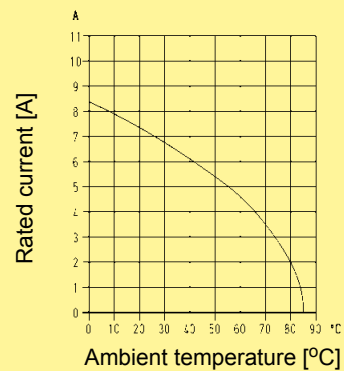



Mating face

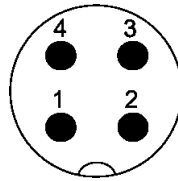

A-coding
Mating face
acc. to IEC 61076-2-101



Applications / Advantages

03

- Actor and sensor applications
- Shielded and unshielded versions
- Available with crimp resp. HARAX® rapid termination, or as overmoulded system cable in various lengths
- Robust design, quick assembly

Identification	Part No.	Drawing	Dimensions in mm
----------------	----------	---------	------------------

HARAX® M12-S



Male
straight version
4 poles, 0.14 - 0.34 mm²

21 03 111 1405

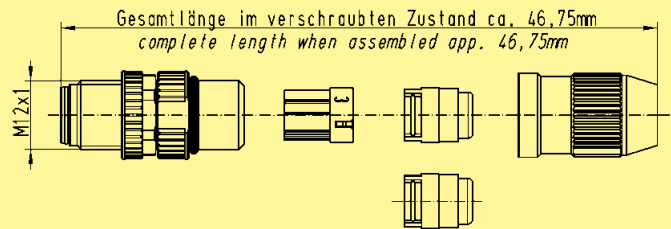

Male
straight version
4 poles, 0.25 - 0.5 mm²

21 03 112 1405

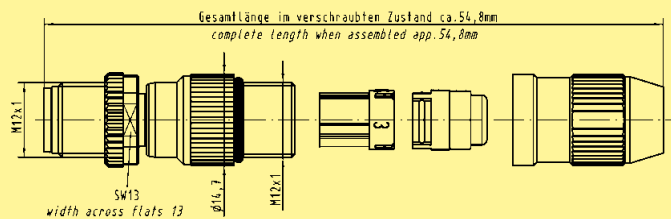

M12 HARAX® A-coded



Mating face

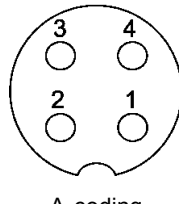

A-coding
Mating face
acc. to IEC 61076-2-101



Identification

Part No.

Drawing

Dimensions in mm

HARAX® M12-S



Female
straight version
4 poles, 0.14 - 0.34 mm²

Female
straight version
4 poles, 0.25 - 0.5 mm²

21 03 111 2405

21 03 112 2405

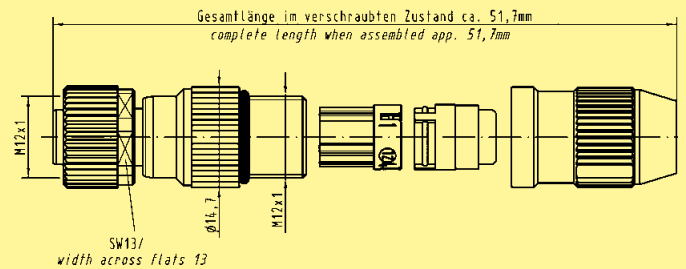
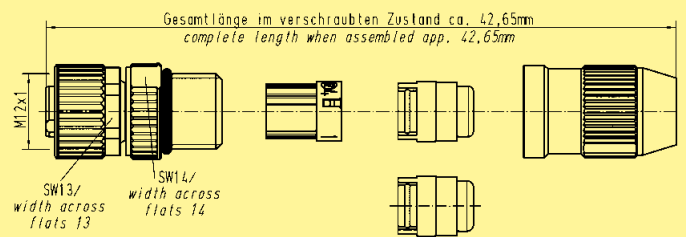

03

03
09

M12 HARAX® A-coded



Mating face

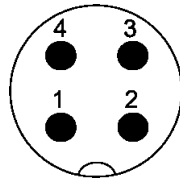

A-coding
Mating face
acc. to IEC 61076-2-101



03

Identification

Part No.

Drawing

Dimensions in mm

HARAX® M12



Male
angled version
4 poles

21 01 140 5081

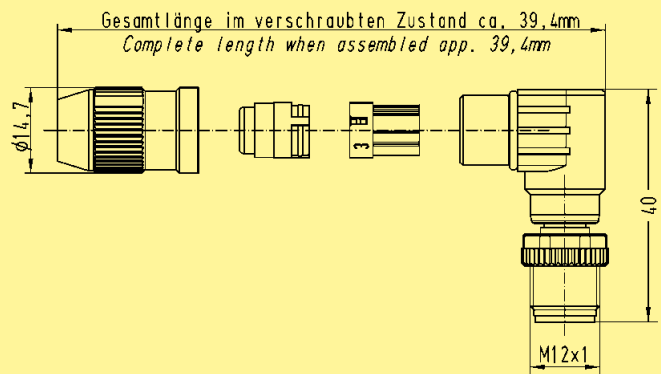

03
10

M12 HARAX® A-coded



Mating face

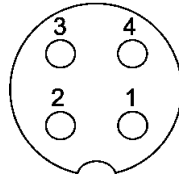

A-coding
Mating face
acc. to IEC 61076-2-101



Identification

Part No.

Drawing

Dimensions in mm

HARAX® M12



Female
angled version
4 poles

21 01 140 5091

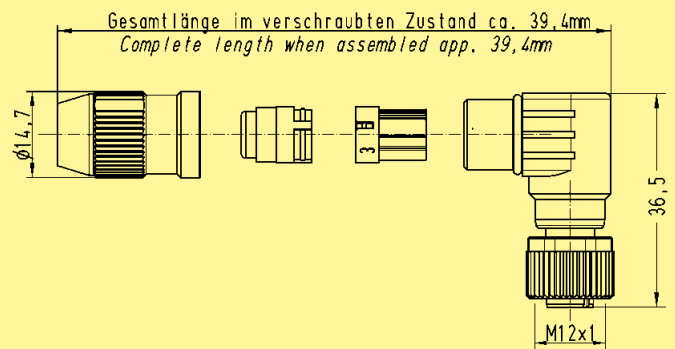

03

M12 HARAX® A-coded



Mating face

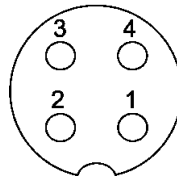

A-coding
Mating face
acc. to IEC 61076-2-101



Identification

Part No.

Drawing

Dimensions in mm

03

HARAX® M12-L, shielded



Female
4 poles, A-coding
0.14 - 0.34 mm² / AWG 26 - 22

21 03 221 2405

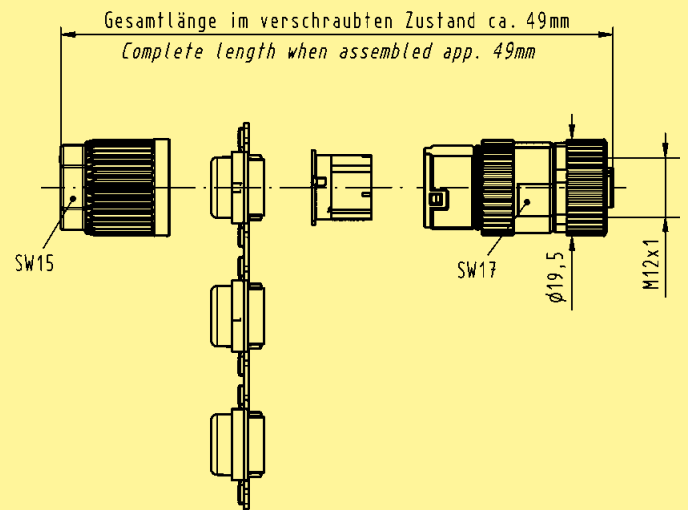

M12 Circular connectors



Female
with IDC termination technology,
8 poles
0.14 - 0.34 mm² / AWG 26 - 22

21 03 121 2801

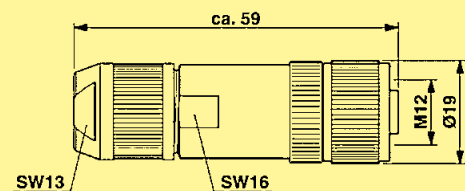

M12 Crimp A-coded



Mating face

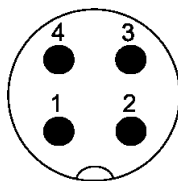

A-coding
Mating face
acc. to IEC 61076-2-101



Identification

Part No.

Drawing

Dimensions in mm

M12 Crimp, angled



Male
5 poles, A-coding

21 03 822 3505*

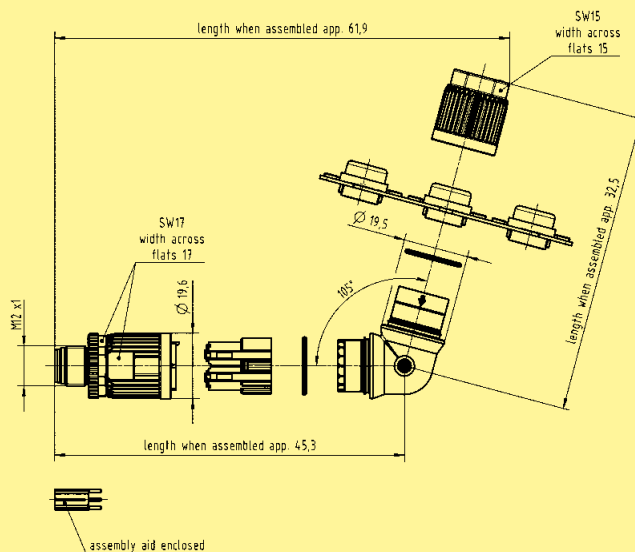

03

03
17

M12 Crimp A-coded



Mating face

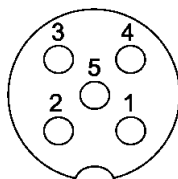

A-coding
Mating face
acc. to IEC 61076-2-101



Identification

Part No.

Drawing

Dimensions in mm

M12 Crimp, angled



Female
5 poles, A-coding

21 03 822 4505*

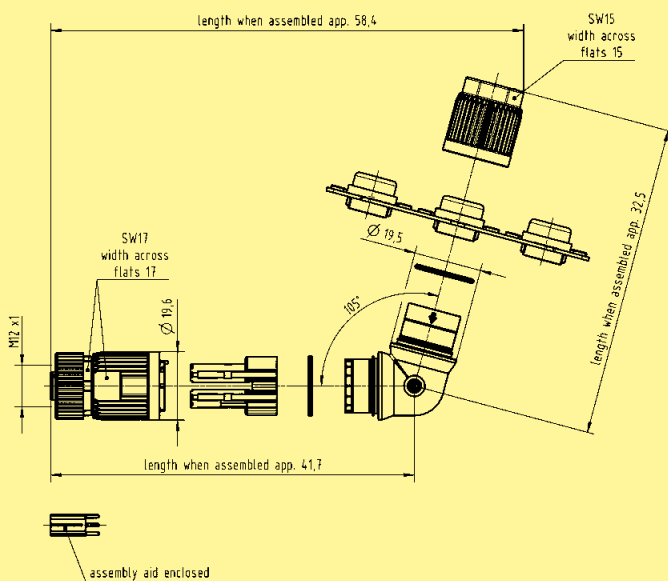

03

03
19

Mating face

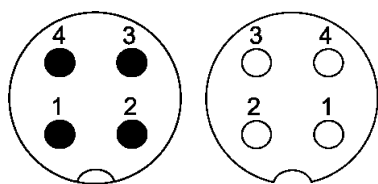

A-coding
Mating face
acc. to IEC 61076-2-101

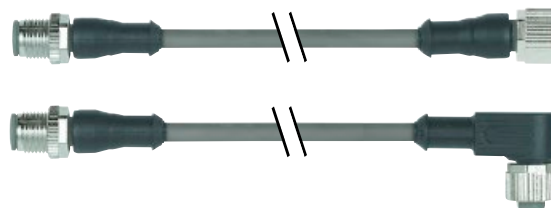

Technical characteristics

M12 Circular connectors, without PE

Rated voltage	max. 250 V AC/DC, max. 30 V DC (with LED)
Rated current / contact	max. 4 A
Locking	Screw locking M12x1, self securing
Recommended torque	0.6 Nm
Temperature range	-25 °C ... +85 °C (dependant on connected conductor)
Degree of protection	IP67
Number of wires / wire gauge	4 x 0.34 mm ²
Conductor insulation	PP (bn, wh, bu, bk)
Arrangement of insulated strands	42 x 0.1 mm
Sheath	PUR (UL, CSA)
Outer diameter	appr. 4.7 mm
Bending radius	10 x outer diameter
Temperature range (working and storage)	-25 °C ... + 80 °C

M12 System cables, A-coded



Mating face

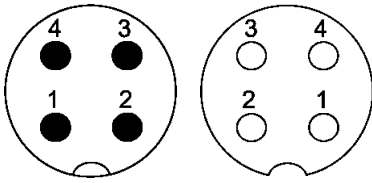



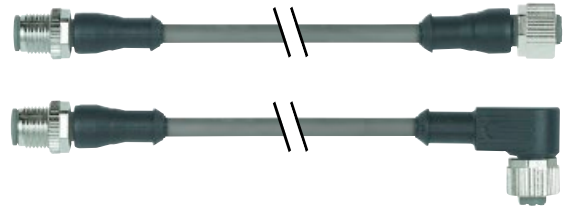

A-coding
Mating face
acc. to IEC 61076-2-101

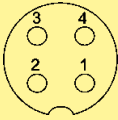
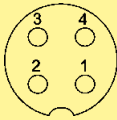
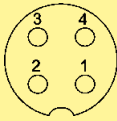

Overview system cables M12

03

Number of contacts		Male M12 A-coding, straight		Female M12 A-coding, angled		
		 Cable material: PUR		 Cable material: PUR		
Female M12	straight		0.3 m	21 03 415 2401	xxx	xxx
			0.6 m	21 03 415 2402	xxx	xxx
			1.0 m	21 03 415 2403	xxx	xxx
			1.5 m	21 03 415 2404	xxx	xxx
			2.0 m	21 03 415 2405	xxx	xxx
	angled		0.3 m	21 03 415 5401	xxx	xxx
			0.6 m	21 03 415 5402	xxx	xxx
			1.0 m	21 03 415 5403	xxx	xxx
			1.5 m	21 03 415 5404	xxx	xxx
			2.0 m	21 03 415 5405	xxx	xxx
Open end		xxx	xxx	1.5 m	21 03 515 4401	
		xxx	xxx	3.0 m	21 03 515 4402	
		xxx	xxx	5.0 m	21 03 515 4403	
		xxx	xxx	7.5 m	21 03 515 4404	
		xxx	xxx	10.0 m	21 03 515 4405	
		xxx	21 03 415 7401 with LED	1.5 m	21 03 515 7401 with LED	
		xxx	21 03 415 7402 with LED	3.0 m	21 03 515 7402 with LED	
		xxx	21 03 415 7403 with LED	5.0 m	21 03 515 7403 with LED	
		xxx	21 03 415 7404 with LED	7.5 m	21 03 515 7404 with LED	
		xxx	21 03 415 7405 with LED	10.0 m	21 03 515 7405 with LED	
M12 cable set for individual assembly incl. HARAX® M12 Male		xxx	xxx	1.5 m	21 83 515 4401	
		xxx	xxx	3.0 m	21 83 515 4402	
		xxx	xxx	5.0 m	21 83 515 4403	
		xxx	xxx	7.5 m	21 83 515 4404	
		xxx	xxx	10.0 m	21 83 515 4405	
		xxx	21 83 515 7401 with LED	1.5 m	21 83 515 7401 with LED	
		xxx	21 83 515 7402 with LED	3.0 m	21 83 515 7402 with LED	
		xxx	21 83 515 7403 with LED	5.0 m	21 83 515 7403 with LED	
		xxx	21 83 515 7404 with LED	7.5 m	21 83 515 7404 with LED	
		xxx	21 83 515 7405 with LED	10.0 m	21 83 515 7405 with LED	

M12 System cables, A-coded



Mating face

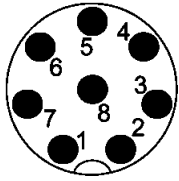

A-coding
Mating face
acc. to IEC 61076-2-101



Overview system cables M12

03

Number of contacts		Male M12 A-coding, straight	
		 Cable material: PUR	
Open end		1.0 m	21 03 514 1801
		2.0 m	21 03 514 1803
		5.0 m	21 03 514 1805

M12 System cables, A-coded



Mating face

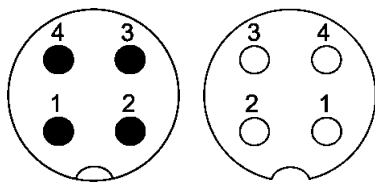

A-coding
Mating face
acc. to IEC 61076-2-101



Identification

Part No.

Drawing

Dimensions in mm

03

M12 Circular connectors
Female straight, male straight

Length: 0.3 m
0.6 m
1.0 m
1.5 m
2.0 m

21 03 415 2401
21 03 415 2402
21 03 415 2403
21 03 415 2404
21 03 415 2405

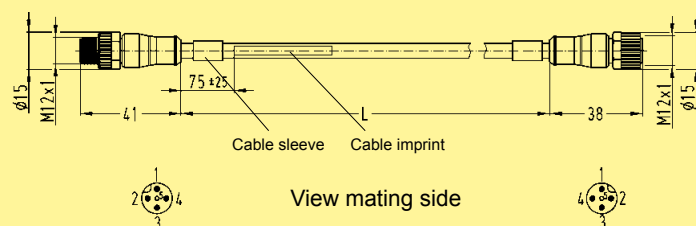

Schematic diagram

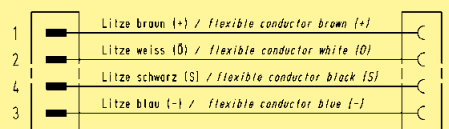

M12 Circular connectors
Female angled, male straight

Length: 0.3 m
0.6 m
1.0 m
1.5 m
2.0 m

21 03 415 5401
21 03 415 5402
21 03 415 5403
21 03 415 5404
21 03 415 5405

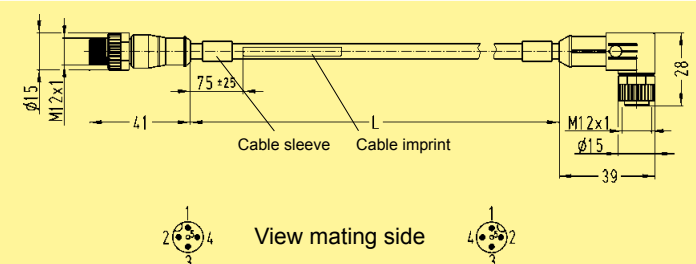

Schematic diagram

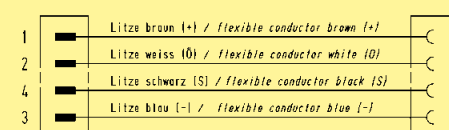

M12 Circular connectors
Female angled, with LED,
Male straight

Length: 0.3 m
0.6 m
1.0 m
1.5 m
2.0 m

21 03 415 7401
21 03 415 7402
21 03 415 7403
21 03 415 7404
21 03 415 7405

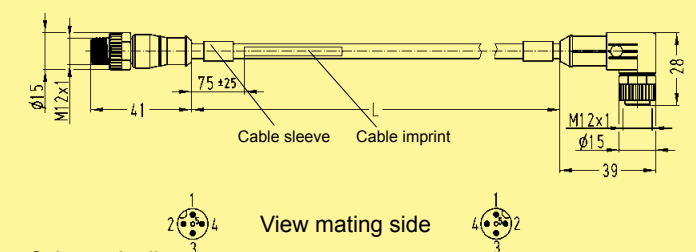

Schematic diagram

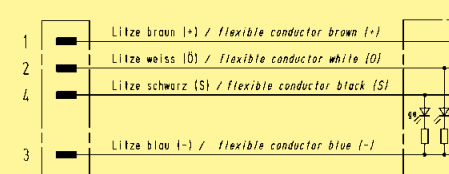

M12 System cables, A-coded



Mating face

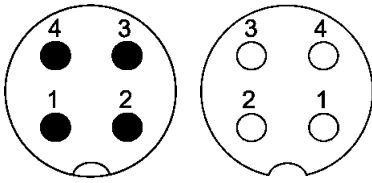

A-coding
Mating face
acc. to IEC 61076-2-101



Identification

Part No.

Drawing

Dimensions in mm

HARAX® M12 Cable set without LED

Delivery range: M12 connector with individually adaptable cable and HARAX® M12-S

Length: 1.5 m
3.0 m
5.0 m
7.5 m
10.0 m

21 83 515 4401
21 83 515 4402
21 83 515 4403
21 83 515 4404
21 83 515 4405

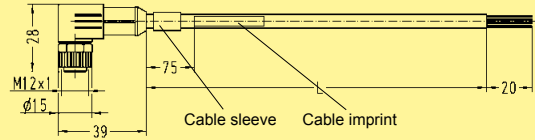

HARAX® M12-S (21 03 111 1405)

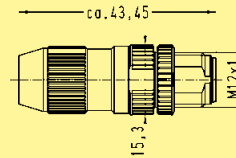

HARAX® M12 Cable set with LED

Delivery range: M12 connector with individually adaptable cable and HARAX® M12-S

Length: 1.5 m
3.0 m
5.0 m
7.5 m
10.0 m

21 83 515 7401
21 83 515 7402
21 83 515 7403
21 83 515 7404
21 83 515 7405

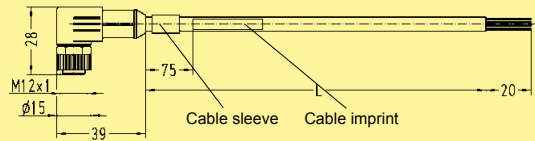

HARAX® M12-S (21 03 111 1405)

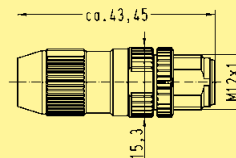

1 x M12 Circular connectors, straight

pre-assembled on one end,
8 poles

Length: 1.0 m
3.0 m
5.0 m

21 03 514 1801
21 03 514 1803
21 03 514 1805

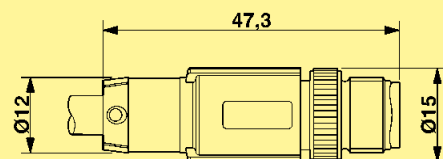

M12 Panel feed-through HARAX® A-coded



Mating face

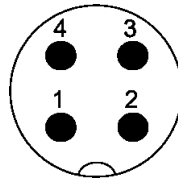

A-coding
Mating face
acc. to IEC 61076-2-101



Applications / Advantages

03

- Actor and sensor applications
- For panel feed-through or PCB, straight version in IP20 or IP67, with or without assembled pigtail
- Available with crimp resp. HARAX® rapid termination
- Quick and easy assembly

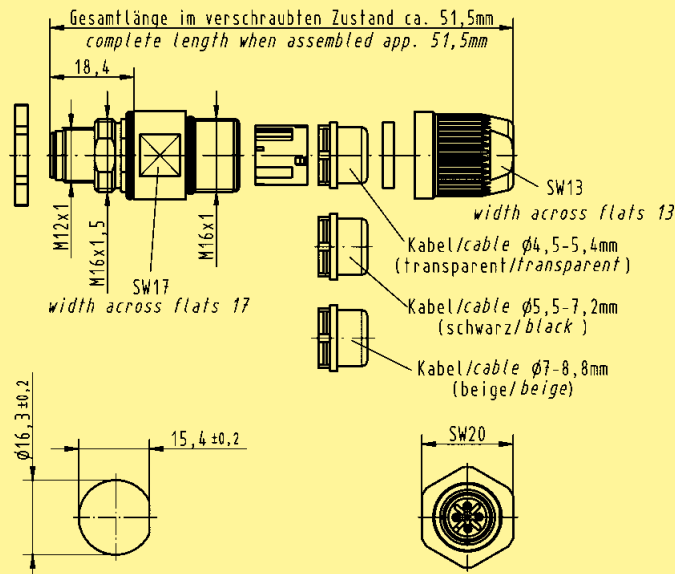
Identification	Part No.	Drawing	Dimensions in mm
<p>HARAX® Panel feed-through</p>  <p>Male 4 poles, A-coding 0.14 - 0.34 mm² / AWG 26 - 22</p> <p>Panel thickness min. 2.5 mm max. 4.5 mm</p>	<p>21 03 321 1425</p>	 <p>Gesamtlänge im verschraubten Zustand ca. 51,5mm complete length when assembled app. 51,5mm</p> <p>18,4</p> <p>M12x1 M16x1,5 M16x1</p> <p>SW17 width across flats 17</p> <p>SW13 width across flats 13</p> <p>Kabel/cable ϕ4,5-5,4mm (transparent/transparent)</p> <p>Kabel/cable ϕ5,5-7,2mm (schwarz/black)</p> <p>Kabel/cable ϕ7-8,8mm (beige/beige)</p> <p>ϕ16,3 \pm0,2</p> <p>15,4 \pm0,2</p> <p>SW20</p>	

03
26

M12 Panel feed-through HARAX® A-coded



Mating face

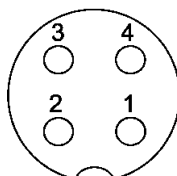

A-coding
Mating face
acc. to IEC 61076-2-101



Identification

Part No.

Drawing

Dimensions in mm

HARAX® Panel feed-through



21 03 321 2425

Female
4 poles, A-coding
0.14 - 0.34 mm² / AWG 26 - 22

Panel thickness
min. 2.5 mm
max. 4.5 mm

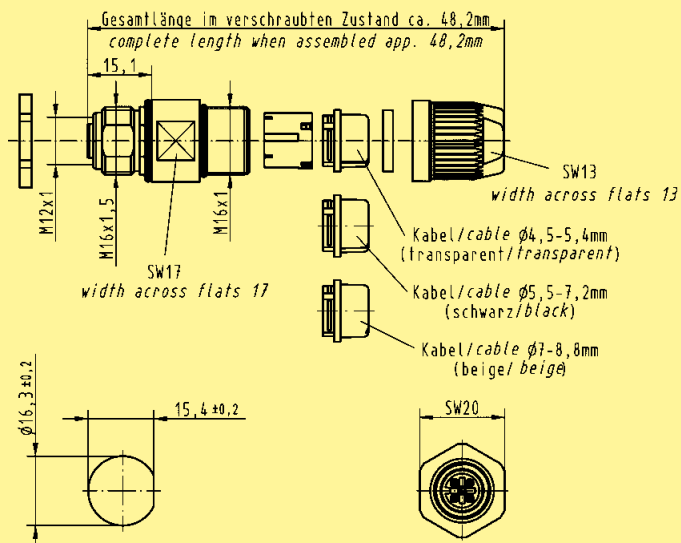

03

03
27

M12 Panel feed-through Crimp A-coded



Mating face

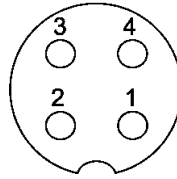

A-coding
Mating face
acc. to IEC 61076-2-101



Identification

Part No.

Drawing

Dimensions in mm

03

M12 Panel feed-through Crimp



Female
4 poles, A-coding

Panel thickness
min. 2.5 mm
max. 4.5 mm

21 03 822 2425

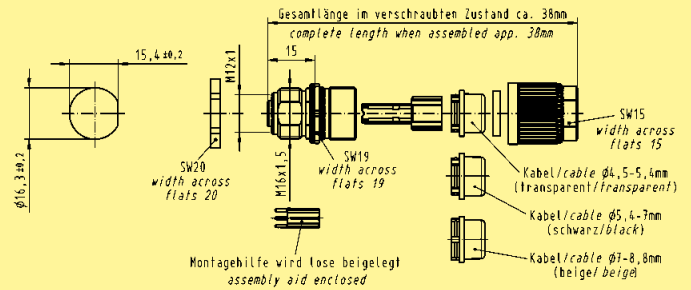

M12 Panel feed-through Crimp



Female
5 poles, A-coding

Panel thickness
min. 2.5 mm
max. 4.5 mm

21 03 822 2525*

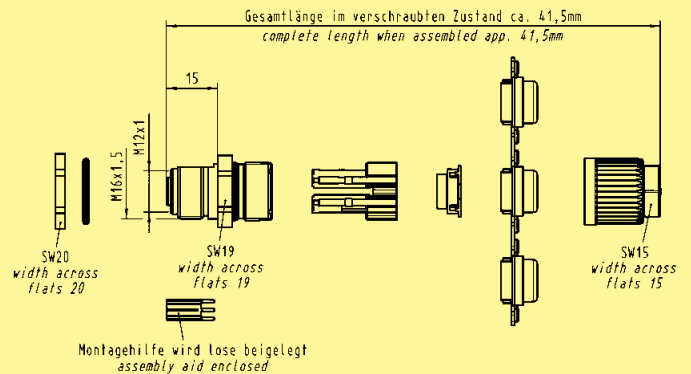

M12 Panel feed-through A-coded



Mating face

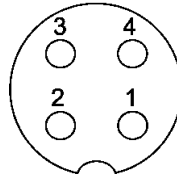

A-coding
Mating face
acc. to IEC 61076-2-101



Identification

Part No.

Drawing

Dimensions in mm

03

M12 Panel feed-through



Female
A-coding,
50 cm conductors, 0.5 mm², 4 poles

Panel thickness
min. 2.0 mm
max. 5.0 mm

21 03 311 2400

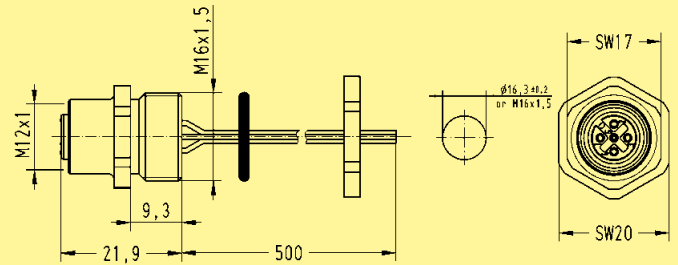

M12 Panel feed-through



Female
A-coding,
50 cm conductors, 0.5 mm², 5 poles

Panel thickness
min. 2.0 mm
max. 5.0 mm

21 03 311 2501

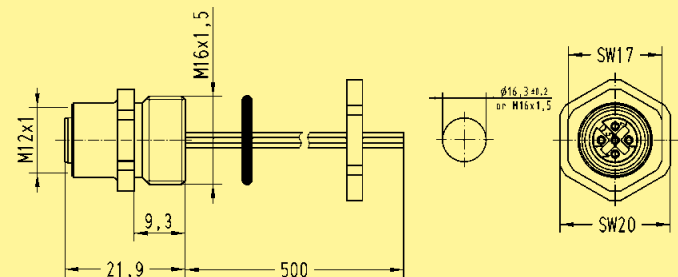

M12 PCB adapter A-coded



Mating face

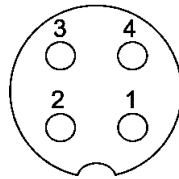

A-coding
Mating face
acc. to IEC 61076-2-101



Identification

Part No.

Drawing

Dimensions in mm

03

M12 PCB adapter

Female, A-coding,
straight



4 poles, IP20
4 poles, IP67

21 03 321 6410
21 03 321 6420*

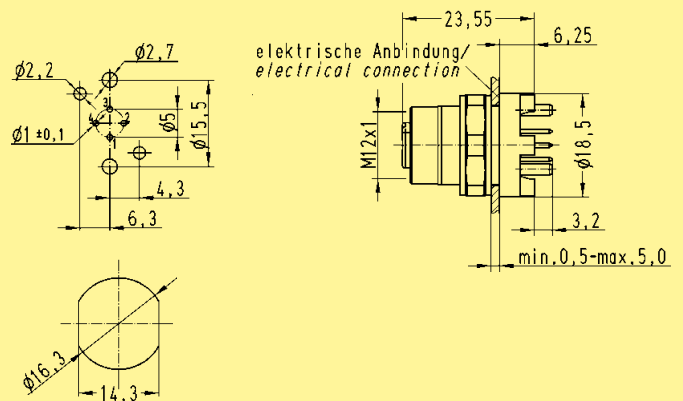

M12 PCB adapter

Female, A-coding,
straight



5 poles, IP20
5 poles, IP67

21 03 321 6510
21 03 321 6520

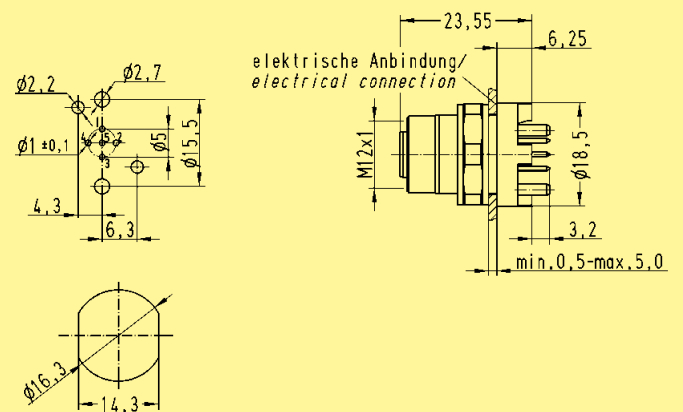

M12 PCB adapter

Female, A-coding,
straight



8 poles, IP67

21 03 311 2801

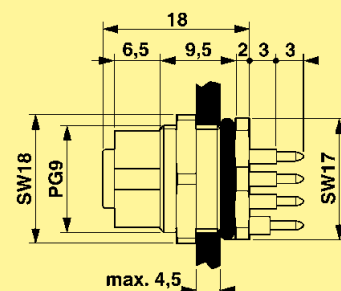

M12 PCB adapter shielded A-coded



Mating face

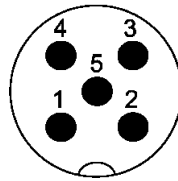

A-coding
Mating face
acc. to IEC 61076-2-101



03

Identification

Part No.

Drawing

Dimensions in mm

M12 PCB adapter, shielded



Male
5 poles, A-coding

8 poles, A-coding

21 03 321 1518*

21 03 321 1818*

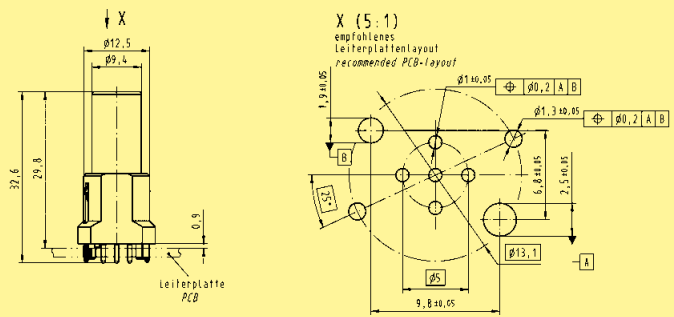

Housing



for rear mounting

for front mounting

21 03 301 1000

21 03 301 1001

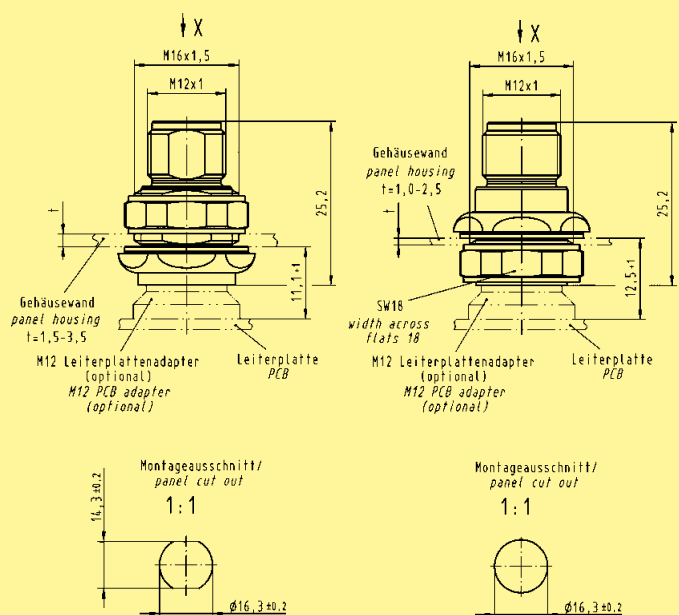

03
34

M12 PCB adapter shielded A-coded



Mating face

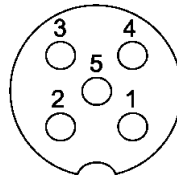

A-coding
Mating face
acc. to IEC 61076-2-101



Identification

Part No.

Drawing

Dimensions in mm

M12 PCB adapter, shielded



Female
5 poles, A-coding

8 poles, A-coding

21 03 321 2518*

21 03 321 2818*

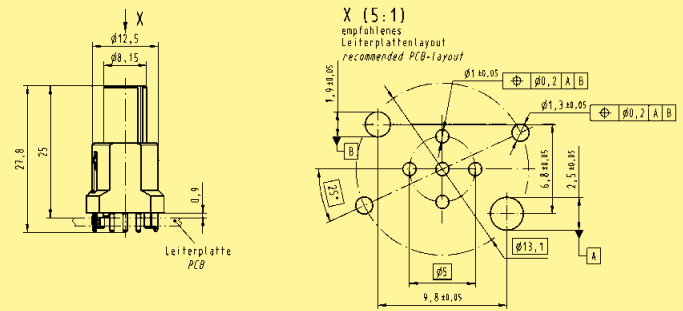

Housing



for rear mounting

for front mounting

21 03 301 2000

21 03 301 2001

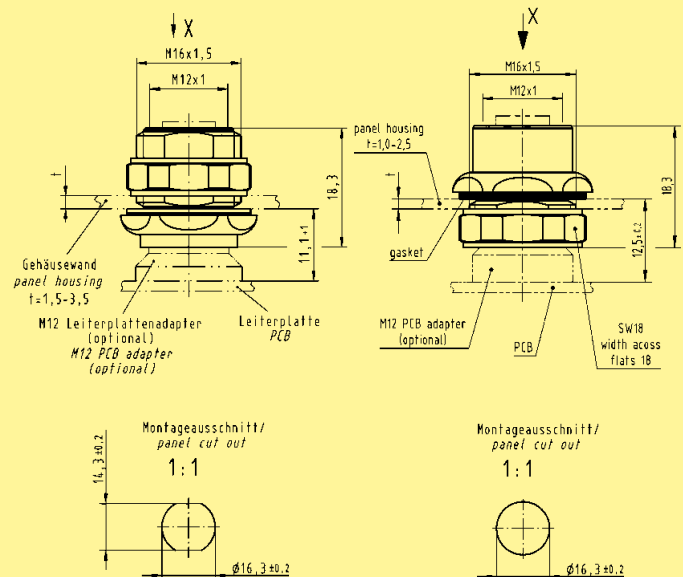

03

Identification

Part No.

Drawing

M12-male moving load
A-coding



21 03 030 1400

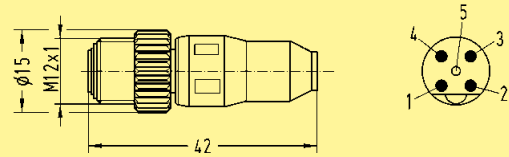

HARTING M12 T-Coupler

21 03 321 9400



Crimping tool for M12 Crimp

09 99 000 0501



Accessories M12 Crimp

Locator

09 99 000 0531



D-Sub contacts

Part number	AWG	Tool settings
09 67 000 3x76	18	6
	20	6
	22	5
09 67 000 8x76	20, 22, 24	6
09 67 000 5x76	22, 24, 26	6

D-Sub single contacts
(500 mating cycles)

turned male contacts

- AWG 22 - 18 / 0.33 - 0.82 mm² 09 67 000 3576
- AWG 24 - 20 / 0.25 - 0.52 mm² 09 67 000 8576
- AWG 26 - 22 / 0.13 - 0.33 mm² 09 67 000 5576



turned female contacts

- AWG 22 - 18 / 0.33 - 0.82 mm² 09 67 000 3476
- AWG 24 - 20 / 0.25 - 0.52 mm² 09 67 000 8476
- AWG 26 - 22 / 0.13 - 0.33 mm² 09 67 000 5476

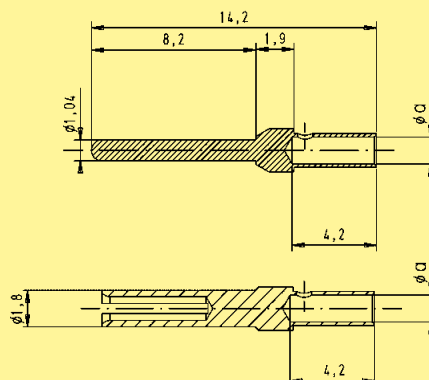

	a
AWG 22 - 18	1.34
AWG 24 - 20	1.13
AWG 26 - 22	0.88









M12 dynamometric screwdriver

Tightening torque 0.6 Nm

- for M12-S SW 13 09 99 000 0382
- for M12 Slim design SW 15 09 99 000 0646
- for M12-L SW 17 09 99 000 0384

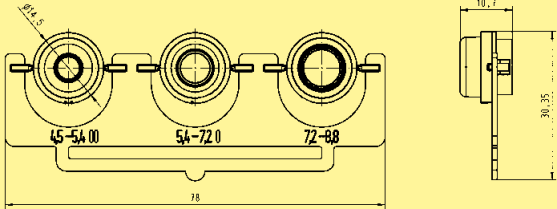

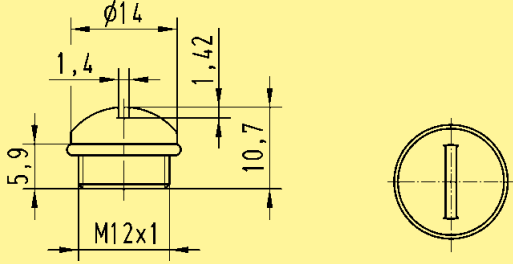
03
36

Identification	Part No.	Drawing	Dimensions in mm
<p>Seal M12-S for 2.9 - 4.0 mm cable Ø for 4 - 5.1 mm cable Ø</p> 	<p>21 01 010 2011 21 01 010 2001</p>		
<p>Seal M12-L unshielded for 4.7 - 6 mm cable Ø for 6 - 8 mm cable Ø</p> 	<p>21 01 010 2015 21 01 010 2007</p>		
<p>Set of seals M12-L shielded for 4.5 - 5.4 mm cable Ø for 5.4 - 7.2 mm cable Ø for 7.2 - 8.8 mm cable Ø</p> 	<p>21 01 010 2017</p>		
<p>Cap M12 for IP65 / IP67 Seals material Viton Plastic cap for female</p> 	<p>21 01 000 0003</p>		
<p>Accessories M12</p> <p>Lock nut</p>	<p>21 01 000 0018</p>		

Identification

Part No.

Drawing

Dimensions in mm

Cap metal M12

for IP65 / IP67
M12 metal cap for male side
with cord

21 01 000 0033

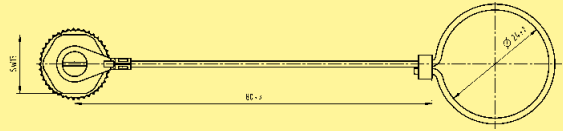

Cap metal M12

for IP65 / IP67
M12 metal cap for male side
with cable clip

21 01 000 0038

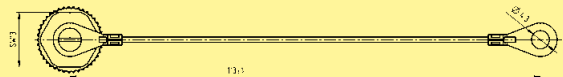

Cap metal M12

for IP65 / IP67
M12 metal cap for female side
with cord

21 01 000 0030

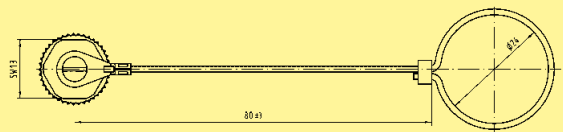

Cap metal M12

for IP65 / IP67
M12 metal cap for female side
with cable clip

21 01 000 0031

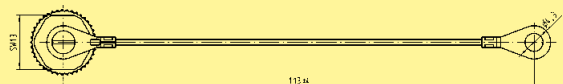

03

03
38

Directory

Page

3.2 B-coded – Solutions for Profibus applications

o Technical characteristics	03.40
■ Cable connectors	
• HARAX® M12 L shielded	03.42
• M12 Crimp	03.44
• System cables	03.46
■ Device connectors	
• Panel feed-through	03.50
• PCB adapter	03.56
o Accessories	03.60

M12 B-coding



Specifications IEC 60 352-4

Approval 



Mating face

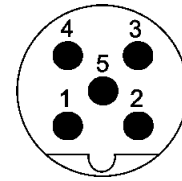

B-coding
Mating face
acc. to IEC 61076-2-101

Technical characteristics M12 – B-coding

03

Type M12 B-coded	HARAX® M12 L shielded	M12 Crimp
------------------	-----------------------	-----------

General data

Conductor cross section	0.25 - 0.34 mm ² AWG 24-22	0.13 - 0.75 mm ² AWG 26-18
Diameter of individual strands	≥ 0.1 mm	X
Conductor insulation material	PVC, Zell-PE	X
Conductor diameter	2 - 2.6 mm	2.0 - 2.3 mm
Cable diameter	7.0 - 8.8 mm	4 poles: 4.5 - 8.8 mm 5 poles: 4.5 - 8.8 mm
Temperature range	-40 °C ... +85 °C	-40 °C ... +85 °C
Temperature during connection	-5 °C ... +50 °C	-5 °C ... +50 °C
Degree of protection	IP65 / IP67	IP67
Mating cycles	100	500
Tightening torque connector / hexagonal wrench	0.6 Nm / SW 17	0.5 Nm / SW 17

Electrical characteristics

Rated current	4 A	4 A
Rated voltage	32 V	250 V
Rated impulse voltage	1.5 kV	1.5 kV
Contact resistance	10 mΩ	10 mΩ
Insulation resistance	10 ⁸ Ω	10 ⁸ Ω
Pollution degree	3	3
Overvoltage category	3	3
Isolation group	1	1

Materials

Contact material	Brass	Brass
Contact plating	Gold	Gold
Contact carrier material	PA unreinforced	PA
Housing material	PA unreinforced	PA

03
40

Technical characteristics M12 – B-coding

Current carrying capacity The current carrying capacity is limited by maximum temperature of materials for inserts and contacts including terminals. The current capacity-curve is valid for continuous, not interruptet current-loaded contacts of connectors when simultaneous power on all contacts is given, without exceeding the maximum temperature.

Control and test procedures according to DIN IEC 60 512-5.

M12-L
3 poles, 4 poles

1 = Wire gauge 0.34 mm²
2 = Wire gauge 0.75 mm²

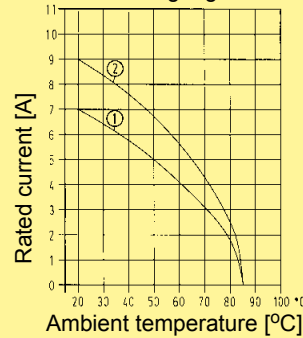

M12, Crimp 1 = Wire gauge 0.34 mm² / 0.5 mm²

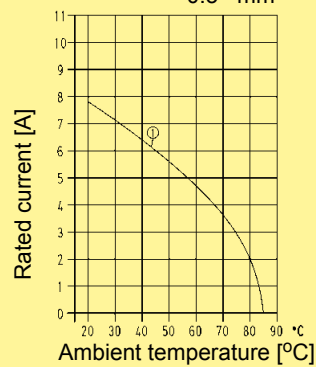



Mating face

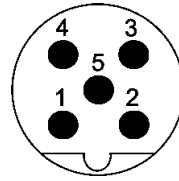

B-coding
Mating face
acc. to IEC 61076-2-101



Applications / Advantages

03

- B-coding for field bus systems e.g. Profibus, DeviceNet or CANopen
- Available with crimp resp. HARAX® rapid termination, or as overmoulded system cable in various lengths
- Shielding by the hood
- Easy handling, quick assembly

Identification

Part No.

Drawing

Dimensions in mm

HARAX® M12-L, shielded



Male
2 poles, B-coding
0.25 - 0.34 mm² / AWG 24 - 22

21 03 241 1301

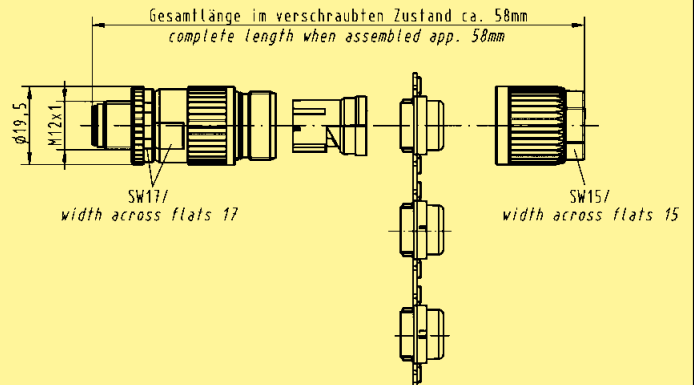

M12 HARAX® B-coded



Mating face

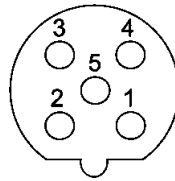

B-coding
Mating face
acc. to IEC 61076-2-101



Identification

Part No.

Drawing

Dimensions in mm

HARAX® M12-L, shielded



21 03 241 2301

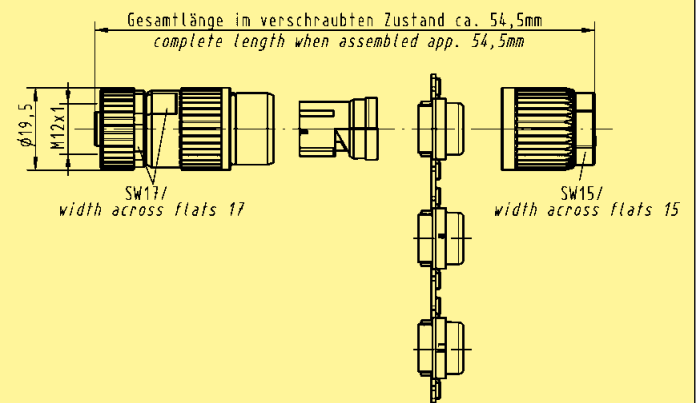

Female
2 poles, B-coding
0.25 - 0.34 mm² / AWG 24 - 22

03

03
43

M12 Crimp B-coded



Mating face

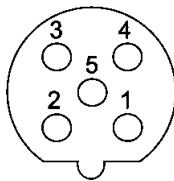

B-coding
Mating face
acc. to IEC 61076-2-101



Identification

Part No.

Drawing

Dimensions in mm

M12 Crimp



Female
5 poles, B-coding

21 03 841 2505

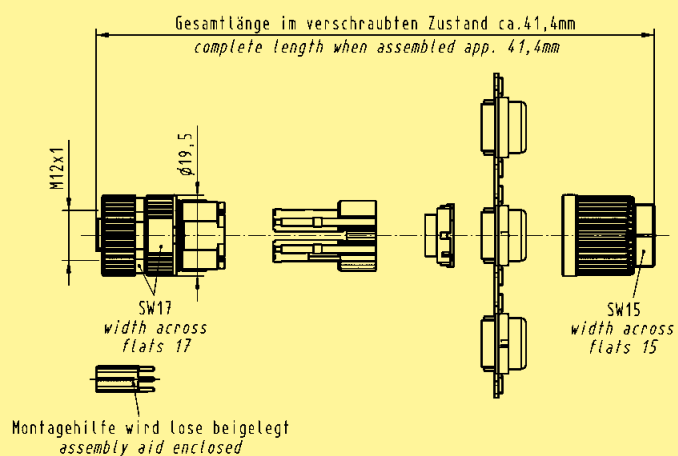

03

Mating face

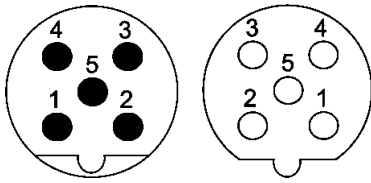

B-coding
Mating face
acc. to IEC 61076-2-101

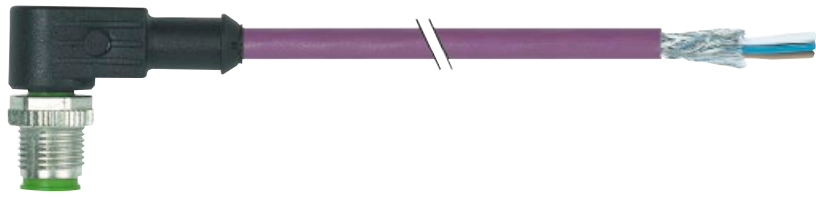

Technical characteristics

Rated voltage	max. 125 V AC/ DC
Rated current / contact	max. 4 A
Locking	Screw locking M12 x 1 mm, self securing
Recommended tightening torque	0.6 Nm
Temperature range (male) °C	-25 °C ... +85 °C, dependant on connected conductor
Degree of protection	IP67
Number of wires / wire gauge	1 x 2 x diameter 0.64 mm
Conductor insulation	PUR (rd, gn)
Arrangement of insulated strands	19 x 0.13 mm
Sheath	PUR (UL/CSA)
Outer diameter	appr. 7.8 mm
Bending radius bewegt	15 x outer diameter
Temperature range °C (applicate with fixed cable)	-30 °C ... + 80 °C

Mating face

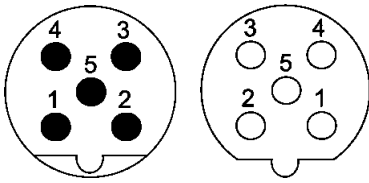

B-coding
Mating face
acc. to IEC 61076-2-101

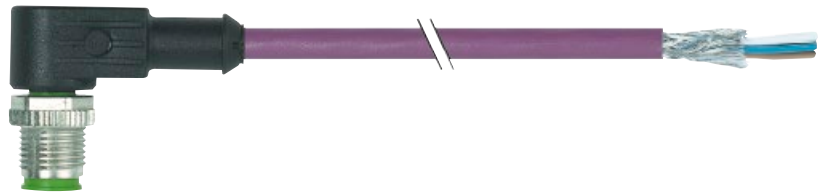

Overview system cables M12

03

		Number of contacts		Male M12 B-coding					
				straight		angled			
Female M12	straight		0.3 m	21 03 449 4301		Cable material: PUR	xxx		
			0.6 m	21 03 449 4302			xxx		
			1.0 m	21 03 449 4303			xxx		
			1.5 m	21 03 449 4304			xxx		
			2.0 m	21 03 449 4305			xxx		
	angled		xxx			Cable material: PUR	0.3 m	21 03 449 6301	
			xxx				0.6 m	21 03 449 6302	
			xxx				1.0 m	21 03 449 6303	
			xxx				1.5 m	21 03 449 6304	
			xxx				2.0 m	21 03 449 6305	
Open end		1.5 m	21 03 549 1301		Cable material: PUR	1.5 m	21 03 549 3301		
		3.0 m	21 03 549 1302			3.0 m	21 03 549 3302		
		5.0 m	21 03 549 1303			5.0 m	21 03 549 3303		
		7.5 m	21 03 549 1304			7.5 m	21 03 549 3304		
		10.0 m	21 03 549 1305			10.0 m	21 03 549 3305		
	Female M12 B-coding	straight		1.5 m	21 03 549 2301		Cable material: PUR	1.5 m	21 03 549 4301
				3.0 m	21 03 549 2302			3.0 m	21 03 549 4302
				5.0 m	21 03 549 2303			5.0 m	21 03 549 4303
				7.5 m	21 03 549 2304			7.5 m	21 03 549 4304
				10.0 m	21 03 549 2305			10.0 m	21 03 549 4305
angled		1.5 m	21 03 549 2301		Cable material: PUR	1.5 m	21 03 549 4301		
		3.0 m	21 03 549 2302			3.0 m	21 03 549 4302		
		5.0 m	21 03 549 2303			5.0 m	21 03 549 4303		
		7.5 m	21 03 549 2304			7.5 m	21 03 549 4304		
		10.0 m	21 03 549 2305			10.0 m	21 03 549 4305		

M12 System cables, B-coding



Mating face

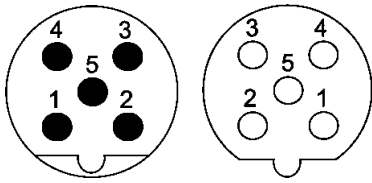

B-coding
Mating face
acc. to IEC 61076-2-101

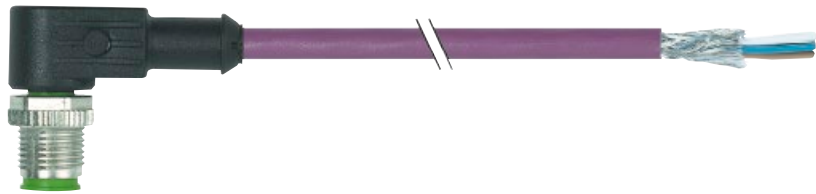

03

Identification

Part No.

Darstellung

M12 Circular connectors, Male, straight

pre-assembled on one end,
useable as trailing cable

Length: 1.5 m
3.0 m
5.0 m
7.5 m
10.0 m

21 03 549 1301
21 03 549 1302
21 03 549 1303
21 03 549 1304
21 03 549 1305



Schematic diagram

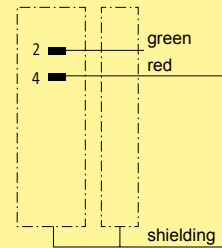

M12 Circular connectors, Male, angled

pre-assembled on one end,
useable as trailing cable

Length: 1.5 m
3.0 m
5.0 m
7.5 m
10.0 m

21 03 549 3301
21 03 549 3302
21 03 549 3303
21 03 549 3304
21 03 549 3305



Schematic diagram

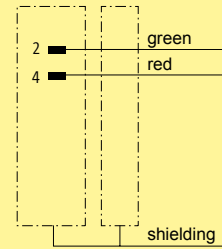

03
48

M12 System cables, B-coding



Mating face

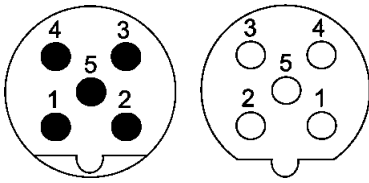

B-coding
Mating face
acc. to IEC 61076-2-101

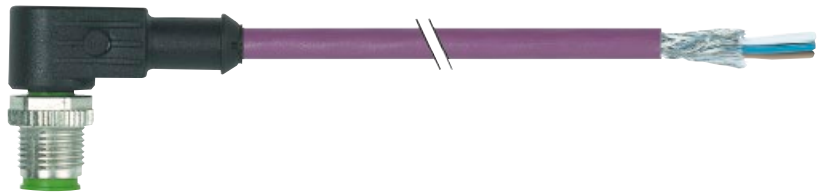

Identification

Part No.

Darstellung

M12 Circular connectors, Female, straight

pre-assembled on one end,
useable as trailing cable

Length: 1.5 m
3.0 m
5.0 m
7.5 m
10.0 m

21 03 549 2301
21 03 549 2302
21 03 549 2303
21 03 549 2304
21 03 549 2305



Schematic diagram

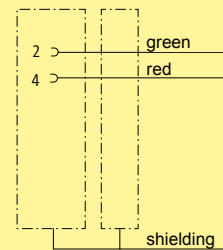

M12 Circular connectors, Female, angled

pre-assembled on one end,
useable as trailing cable

Length: 1.5 m
3.0 m
5.0 m
7.5 m
10.0 m

21 03 549 4301
21 03 549 4302
21 03 549 4303
21 03 549 4304
21 03 549 4305



Schematic diagram

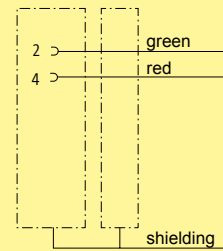

M12 Circular connectors, Male, straight Female, straight

pre-assembled on one end,
useable as trailing cable

Length: 0.3 m
0.6 m
1.0 m
1.5 m
2.0 m

21 03 449 4301
21 03 449 4302
21 03 449 4303
21 03 449 4304
21 03 449 4305

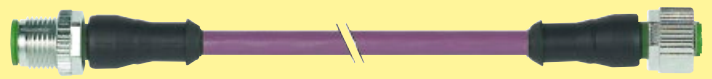

Schematic diagram

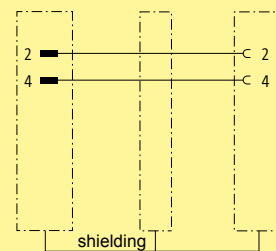

M12 Circular connectors, Male, angled Female, angled

pre-assembled on one end,
useable as trailing cable

Length: 0.3 m
0.6 m
1.0 m
1.5 m
2.0 m

21 03 449 6301
21 03 449 6302
21 03 449 6303
21 03 449 6304
21 03 449 6305



Schematic diagram

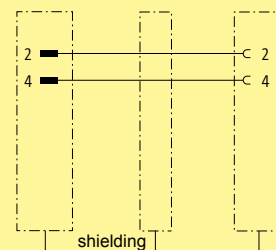

03

03
49

M12 Panel feed-through HARAX® B-coded



Mating face

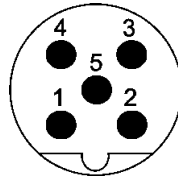

B-coding
Mating face
acc. to IEC 61076-2-101



Applications / Advantages

03

- B-coding for field bus systems e.g. Profibus, DeviceNet or CANopen
- For panel feed-through or PCB, straight version in IP20 or IP67, with or without assembled pigtail
- Available with crimp resp. HARAX® rapid termination
- Quick and easy assembly

Identification	Part No.	Drawing	Dimensions in mm
----------------	----------	---------	------------------

HARAX® Panel feed-through



21 03 341 1425

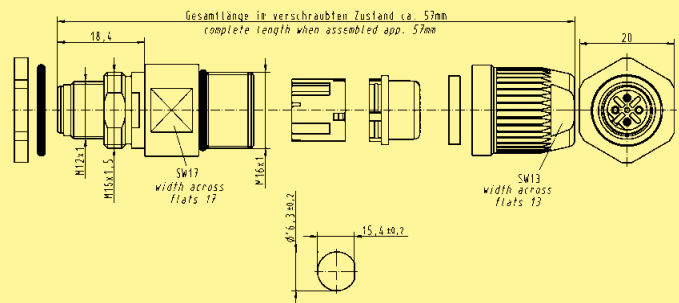

Male
2 poles and shielding, B-coding
0.25 - 0.34 mm² / AWG 24 - 22

Cable diameter: 7 - 8.8 mm

Panel thickness
min. 2.5 mm
max. 4.5 mm

03
50

M12 Panel feed-through HARAX® B-coded



Mating face

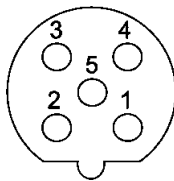

B-coding
Mating face
acc. to IEC 61076-2-101



Identification

Part No.

Drawing

Dimensions in mm

HARAX® Panel feed-through



21 03 341 2425

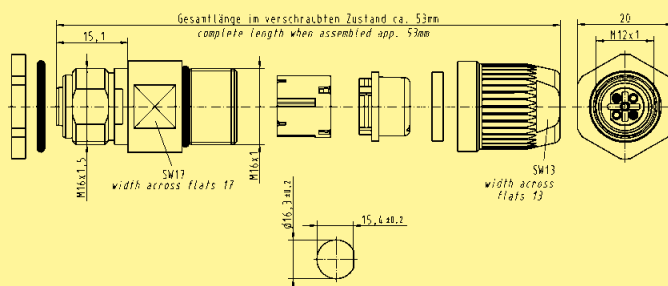

Female
2 poles and shielding, B-coding
0.25 - 0.34 mm² / AWG 24 - 22

Cable diameter: 7 - 8.8 mm

Panel thickness
min. 2.5 mm
max. 4.5 mm

03

M12 Panel feed-through Crimp B-coded



Mating face

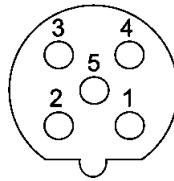

B-coding
Mating face
acc. to IEC 61076-2-101



Identification

Part No.

Drawing

Dimensions in mm

M12 Panel feed-through Crimp



Female
5 poles, B-coding

Panel thickness
min. 2.5 mm
max. 4.5 mm

21 03 841 2525

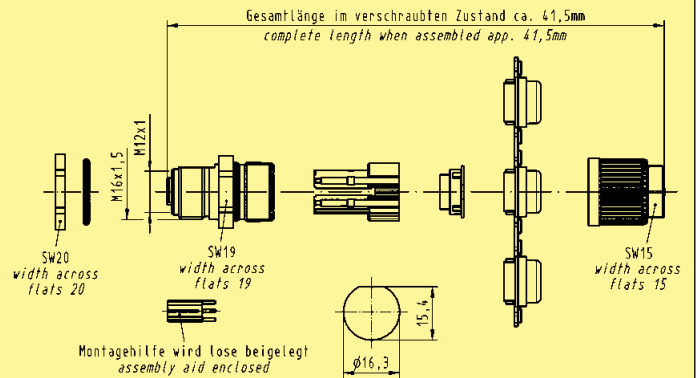

03

M12 Panel feed-through B-coded

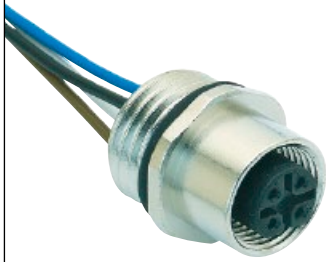

Mating face

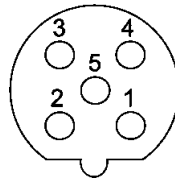

B-coding
Mating face
acc. to IEC 61076-2-101



Identification

Part No.

Drawing

Dimensions in mm

M12 Panel feed-through



Female
B-coding, 20 cm conductors,
0.25 mm²

Panel thickness
min. 2.0 mm
max. 5.0 mm

21 03 339 2301

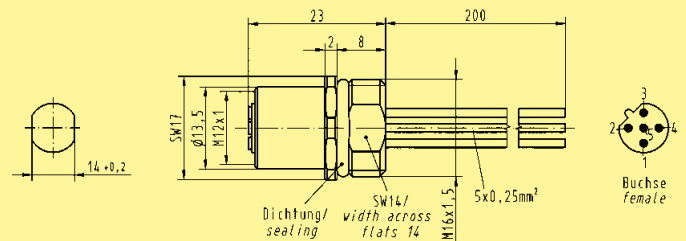

03

03
55

M12 PCB adapter B-coded



Mating face

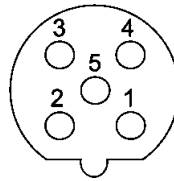

B-coding
Mating face
acc. to IEC 61076-2-101



Identification

Part No.

Drawing

Dimensions in mm

M12 PCB adapter

Female, B-coding,
straight



5 poles, IP20

21 03 341 2505

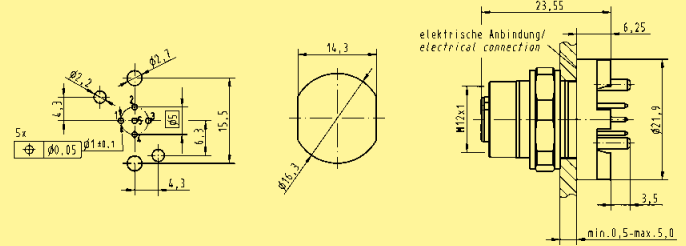

03

03
57

M12 PCB adapter shielded B-coded



Mating face

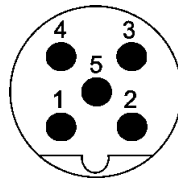

B-coding
Mating face
acc. to IEC 61076-2-101



03

Identification

Part No.

Drawing

Dimensions in mm

M12 PCB adapter, shielded



Male
5 poles, B-coding

21 03 341 1518*

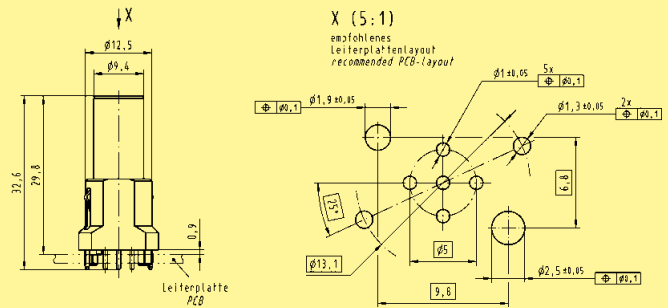

Housing



for rear mounting

21 03 301 1000

for front mounting

21 03 301 1001

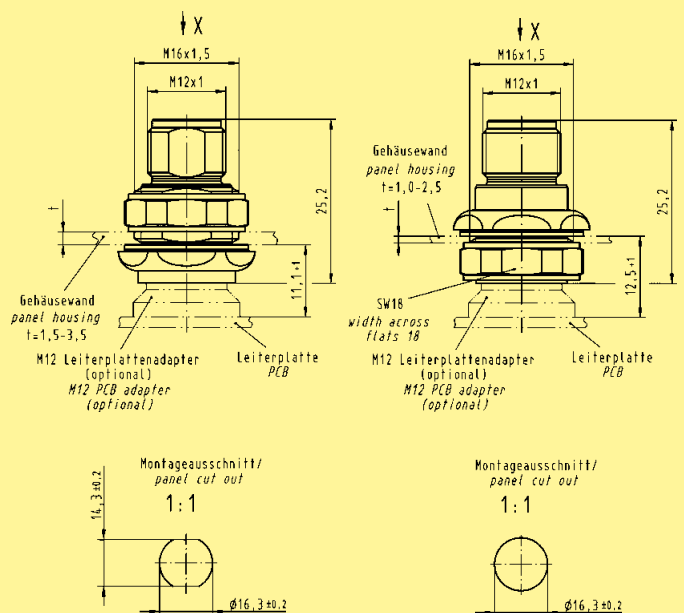

03
58

Identification

Part No.

Drawing

Crimping tool
for M12 Crimp

09 99 000 0501

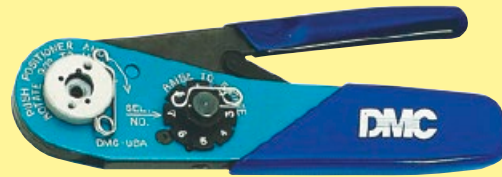

Accessories M12 Crimp

Locator

09 99 000 0531



D-Sub contacts

Part number	AWG	Tool settings
09 67 000 3x76	18	6
	20	6
	22	5
09 67 000 8x76	20, 22, 24	6
09 67 000 5x76	22, 24, 26	6

D-Sub single contacts
(500 mating cycles)

turned male contacts

AWG 22-18 / 0.33-0.82 mm² 09 67 000 3576

AWG 24-20 / 0.25-0.52 mm² 09 67 000 8576

AWG 26-22 / 0.13-0.33 mm² 09 67 000 5576



turned female contacts

AWG 22-18 / 0.33-0.82 mm² 09 67 000 3476

AWG 24-20 / 0.25-0.52 mm² 09 67 000 8476

AWG 26-22 / 0.13-0.33 mm² 09 67 000 5476

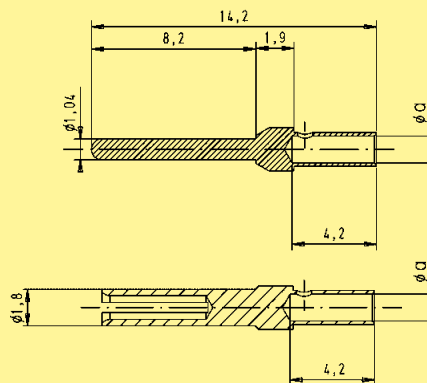

	a
AWG 22-18	1.34
AWG 24-20	1.13
AWG 26-22	0.88

M12
dynamometric screwdriver

Tightening torque 0.6 Nm

for M12-S SW 13 09 99 000 0382

for M12-L SW 17 09 99 000 0384



Cap M12





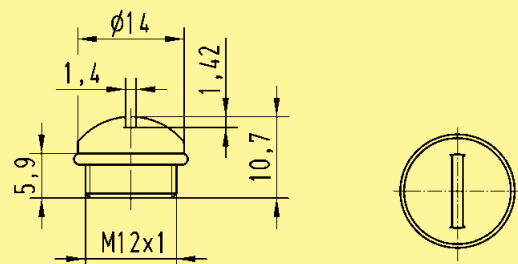

for IP65 / IP67

Seals material Viton

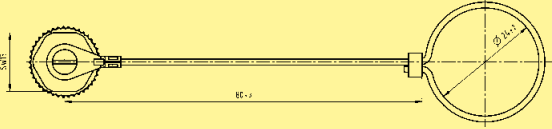
Plastic cap for female

21 01 000 0003

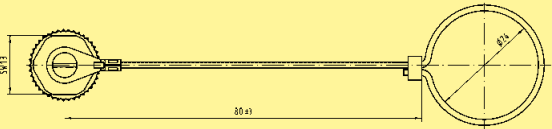

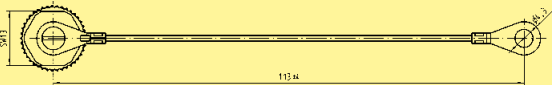
Identification	Part No.	Drawing	Dimensions in mm
<p>Cap metal M12 for IP65 / IP67 M12 metal cap for male side with cord</p> 	<p>21 01 000 0033</p>		<p>03</p>
<p>Cap metal M12 for IP65 / IP67 M12 metal cap for male side with cable clip</p> 	<p>21 01 000 0038</p>		
<p>Cap metal M12 for IP65 / IP67 M12 metal cap for female side with cord</p> 	<p>21 01 000 0030</p>		
<p>Cap metal M12 for IP65 / IP67 M12 metal cap for female side with cable clip</p> 	<p>21 01 000 0031</p>		<p>03 61</p>

Identification

Part No.

Drawing

Dimensions in mm

M12-male moving load
B-coding



21 03 030 1300

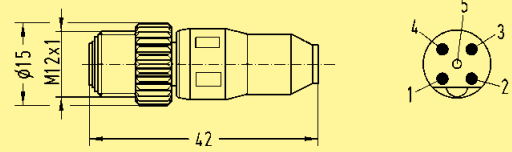

HARTING M12 T-Coupler

21 03 341 6401



Seal M12-L unshielded
for 4.7 - 6 mm cable Ø
for 6 - 8 mm cable Ø



21 01 010 2015
21 01 010 2007



Set of seals M12-L shielded
for 4.5 - 5.4 mm cable Ø
for 5.4 - 7.2 mm cable Ø
for 7.2 - 8.8 mm cable Ø



21 01 010 2017

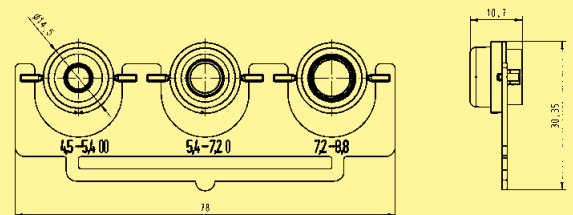

Accessories M12

Lock nut

21 01 000 0018



Directory

Page

3.3 D-coded – Solutions for Ethernet applications

o Technical characteristics	03.64
■ Cable connectors	
• HARAX® M12 L shielded	03.66
• M12 Crimp	03.68
• M12 preLink®	03.71
• System cables	03.73
■ Device connectors	
• Panel feed-through	03.78
• PCB adapter	03.86
o Accessories	03.91

M12 D-coding



Specifications IEC 60 352-4

Approval 

Mating face

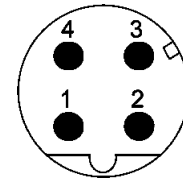

D-coding
Mating face
acc. to IEC 61076-2-101

Technical characteristics M12 – D-coding

03

Type M12 D-coded	HARAX® M12 L shielded	M12 Crimp	M12 preLink®
------------------	-----------------------	-----------	--------------

General data

Conductor cross section	0.14 - 0.34 mm ² AWG 26-22 0.34 - 0.5 mm ² AWG 22-20	0.13 - 0.75 mm ² AWG 26-18	0.10 - 0.34 mm ² AWG 27-22
Diameter of individual strands	≥ 0.1 mm	X	≥ 0.1 mm
Conductor insulation material	PVC/PE	X	PVC/PE
Conductor diameter	1.2 - 2.0 mm	2.0 - 2.3 mm	0.8 - 1.6 mm
Cable diameter	4.5 - 8.8 mm	4 poles: 4.5 - 8.8 mm 5 poles: 4.5 - 8.8 mm	6.3 - 6.7 mm
Temperature range	-40 °C ... +85 °C	-40 °C ... +85 °C	-40 °C ... +85 °C
Temperature during connection	-5 °C ... +50 °C	-5 °C ... +50 °C	–
Degree of protection	IP65 / IP67	IP67	IP65
Mating cycles	100	500	250
Tightening torque connector / Hexagonal wrench	0.6 Nm / SW 17	0.6 Nm / SW 17	0.6 Nm / SW 17

Electrical characteristics

Rated current	4 A	4 A	1 A
Rated voltage	50 V	250 V	48 V
Rated impulse voltage	1.5 kV	1.5 kV	1.5 kV
Contact resistance	10 mΩ	10 mΩ	10 mΩ
Insulation resistance	10 ⁸ Ω	10 ⁸ Ω	10 ⁸ Ω
Pollution degree	3	3	3
Overvoltage category	3	3	3
Isolation group	1	1	–
Transmission performance (Category)	Cat. 5	Cat. 5	Cat. 5

Materials

Contact material	Brass	Brass	Brass
Contact plating	Gold	Gold	Gold
Contact carrier material	PA unreinforced	PA	–
Housing material	PA unreinforced	PA	Zinc die-cast

03
64

Technical characteristics M12 – D-coding

Current carrying capacity The current carrying capacity is limited by maximum temperature of materials for inserts and contacts including terminals. The current capacity-curve is valid for continuous, not interrupted current-loaded contacts of connectors when simultaneous power on all contacts is given, without exceeding the maximum temperature.

Control and test procedures according to DIN IEC 60512-5.

M12-L
3 poles, 4 poles
1 = Wire gauge 0.34 mm²
2 = Wire gauge 0.75 mm²

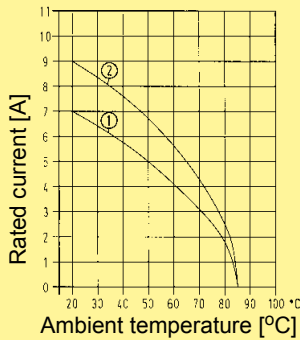

M12, Crimp 1 = Wire gauge 0.34 mm² / 0.5 mm²

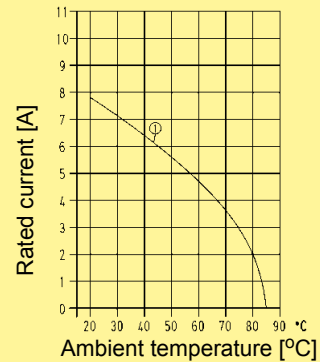

Technical characteristics M12 – D-coding, PCB adapter

M12, D-coding, straight, female, 4 poles
Wire gauge 0.5 mm²

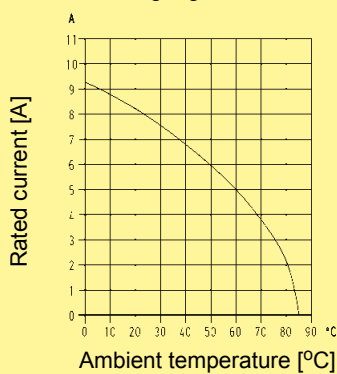

M12, D-coding, angled, female, 4 poles
Wire gauge AWG 22

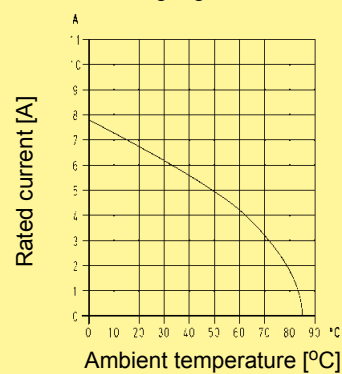



Mating face

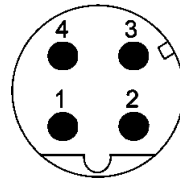

D-coding
Mating face
acc. to IEC 61076-2-101



Applications / Advantages

03

- D-coding for Ethernet/Profinet applications
- Robust design
- 360° shielding termination
- Transmission performance Cat. 5

Identification	Part No.	Drawing	Dimensions in mm
----------------	----------	---------	------------------

HARAX® M12-L, shielded



Male
4 poles, D-coding
0.14 - 0.34 mm², AWG 26 - 22

21 03 281 1405

Male
4 poles, D-coding
0.34 - 0.5 mm², AWG 22 - 20

21 03 282 1405

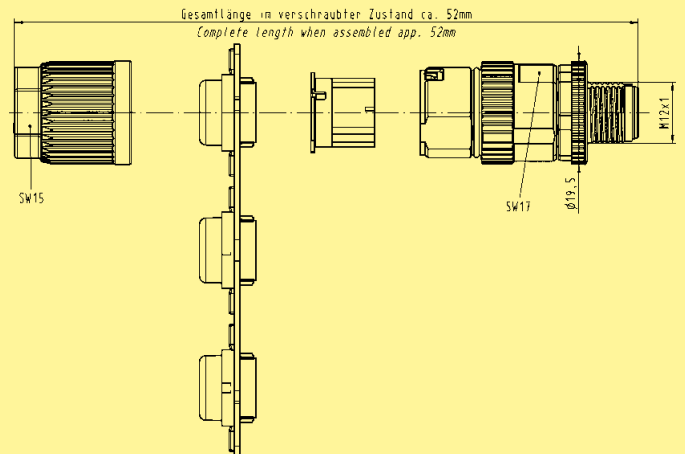

M12 HARAX® D-coded



Mating face

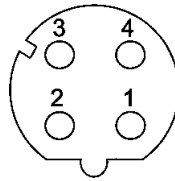

D-coding
Mating face
acc. to IEC 61076-2-101



Identification

Part No.

Drawing

Dimensions in mm

HARAX® M12-L, shielded



Female
4 poles, D-coding
0.14 - 0.34 mm², AWG 26 - 22

21 03 281 2405

Female
4 poles, D-coding
0.34 - 0.5 mm², AWG 22 - 20

21 03 282 2405

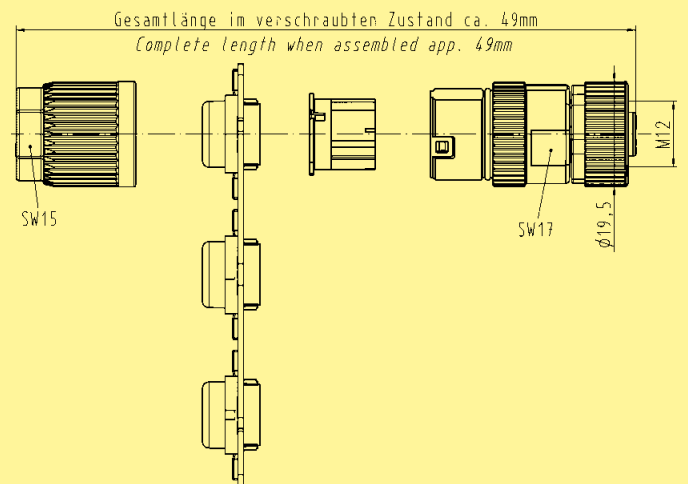

03

M12 Crimp D-coded



Mating face

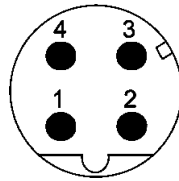

D-coding
Mating face
acc. to IEC 61076-2-101



Identification

Part No.

Drawing

Dimensions in mm

M12 Crimp Slim design, shielded



Male
4 poles, D-coding
Cable: 4.4 - 8.8 mm
outer diameter

21 03 881 1405*

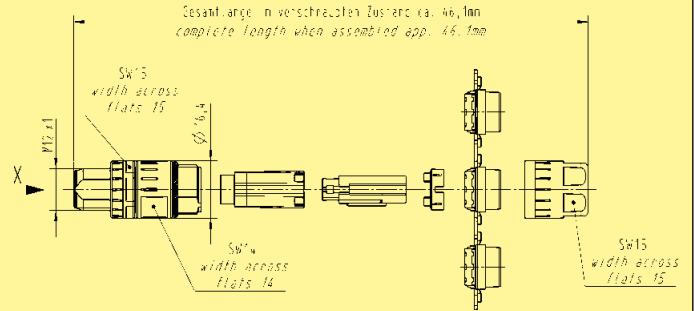

M12 Crimp, shielded



Male
4 poles, D-coding
angled

21 03 882 3405*

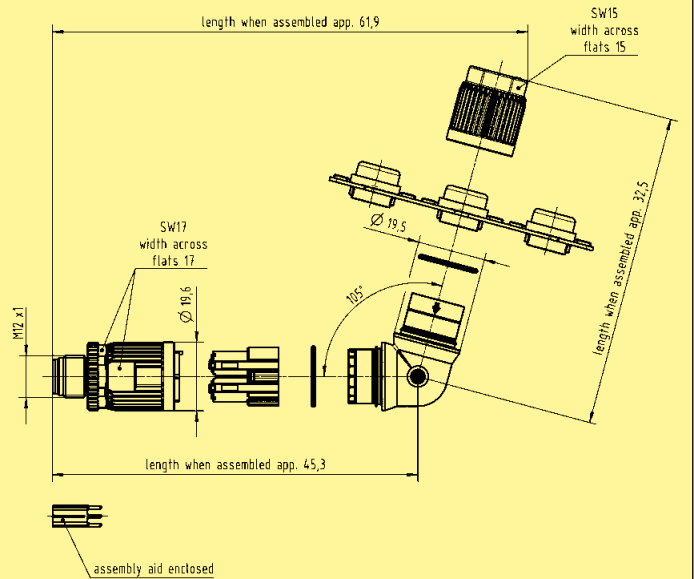

03

03
69

M12 preLink® D-coded



Mating face

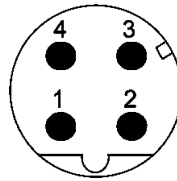

D-coding
Mating face
acc. to IEC 61076-2-101



Identification

Part No.

Drawing

Dimensions in mm

03

preLink® M12 housing

20 82 000 1210

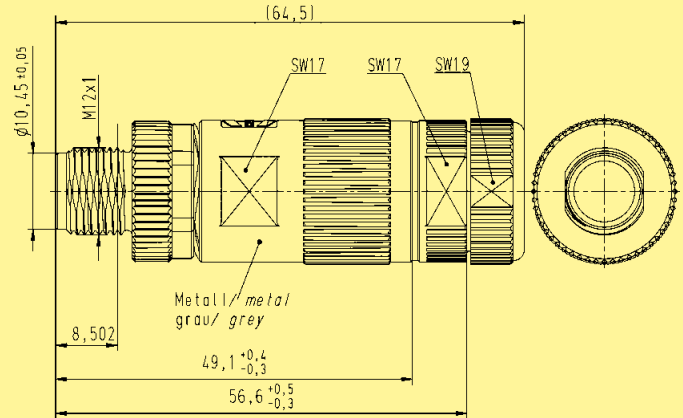

preLink® M12 male module

20 82 005 1214

Male
4 poles, D-coding

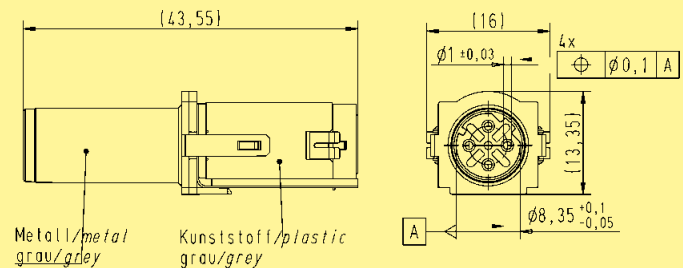

preLink® terminal module
(Pack with 10 pieces)
terminal block with IDC termination

20 82 000 0001

Number of contacts: 8

Conductor cross section: AWG 22/23 (24)
solid and
stranded

Conductor diameter: ϕ 1.3 - 1.6 mm
Colour: yellow

Conductor cross section: AWG 26/27
solid and
stranded

Conductor diameter: ϕ 0.8 - 1.1 mm
Colour: white

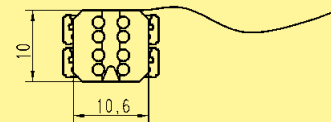

20 82 000 0003

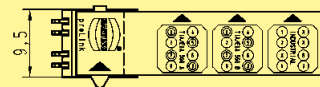

Assembly tool

20 82 000 9901

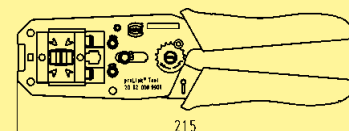

03
71

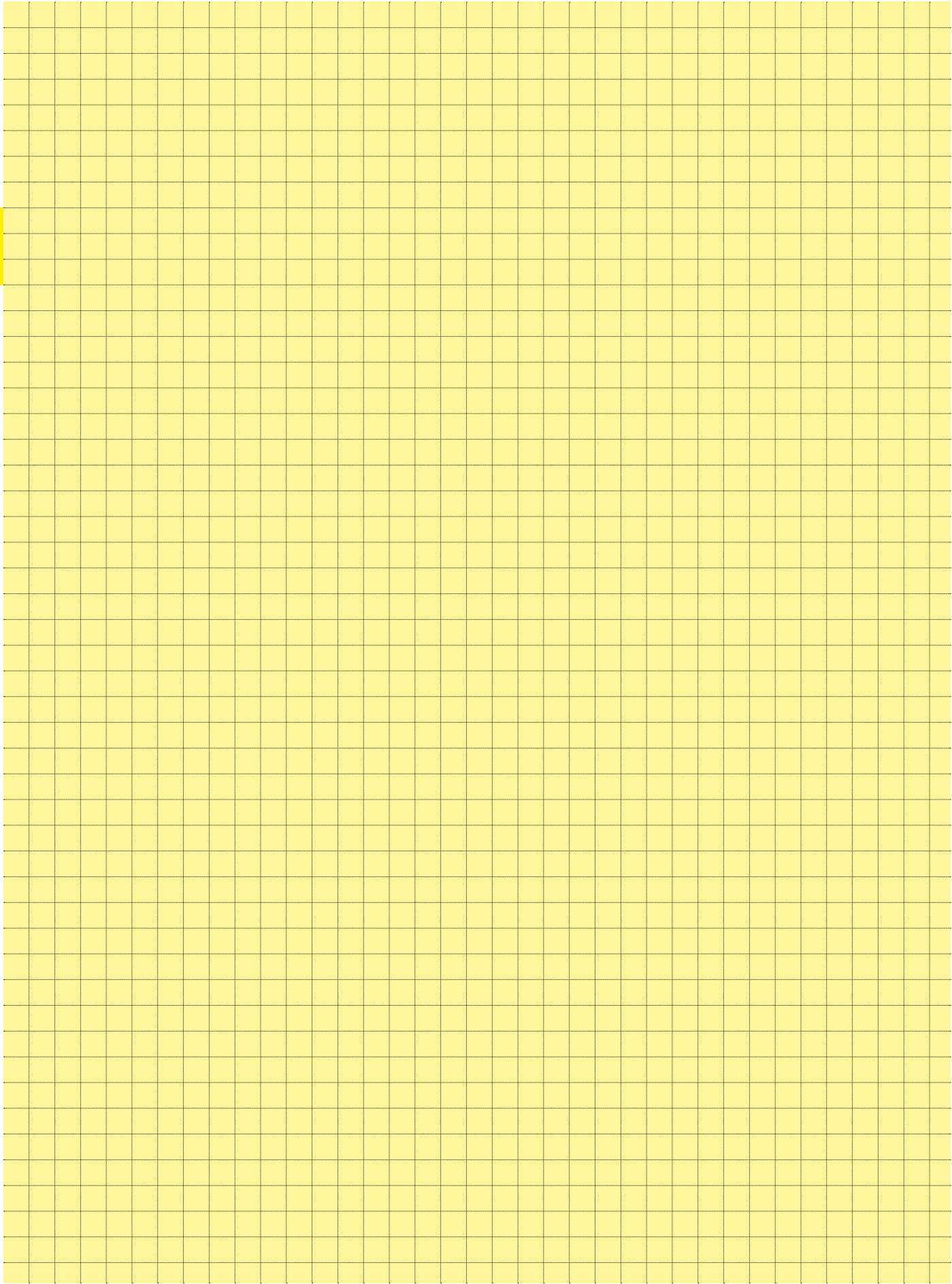

Mating face

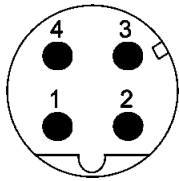

D-coding
Mating face
acc. to IEC 61076-2-101

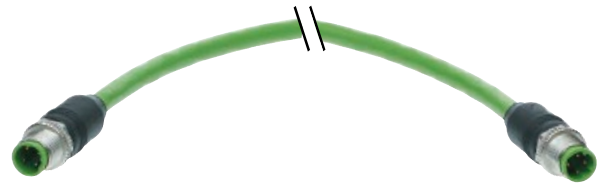

Technical characteristics

Pre-assembled and tested system cables

for structured cabling of industrial Ethernet networks, based on M12 Circular connectors, D-coded

Cable type:	Shielded Twisted Pair Standard Cable
Mating interface:	M12 D-coded acc. to IEC 61 076-2-101
Transmission performance acc. to ISO/IEC 11801:2002:	Class D, 100% tested
Degree of protection	IP65 / IP67 (when mated)

Pin assignment

Signal	Function	Conductor colour PROFINet®	Contact assignment
TD+	Transmission Data+	Yellow	1
TD-	Transmission Data-	Orange	3
RD+	Receiver Data+	White	2
RD-	Receiver Data-	Blue	4

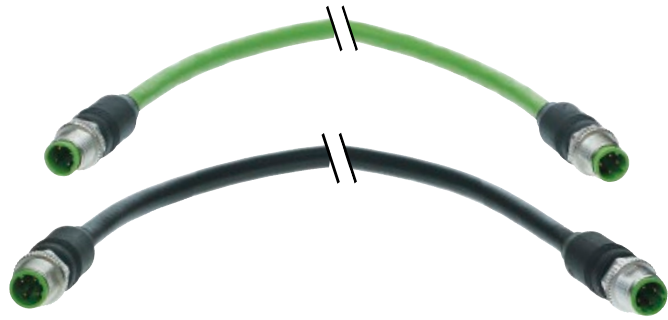
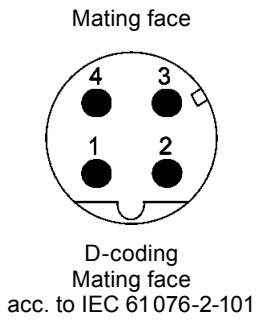

Overview system cables M12

03

Number of contacts			Male M12 D-coding straight			
			Cable material: PUR		Cable material: PVC	
			1.0 m	1.5 m	3.0 m	5.0 m
Male M12 straight			1.0 m	21 03 485 1401 09 48 222 2004 010*	1.0 m	09 47 222 2002 09 48 222 2003 010*
			1.5 m	21 03 485 1451 09 48 222 2004 015*	1.5 m	09 47 222 2003 09 48 222 2003 015*
			3.0 m	21 03 485 1403 09 48 222 2004 030*	3.0 m	09 47 222 2005 09 48 222 2003 030*
			5.0 m	21 03 485 1405 09 48 222 2004 050*	5.0 m	09 47 222 2006 09 48 222 2003 050*
			7.5 m	21 03 485 1457 09 48 222 2004 075*	7.5 m	09 47 222 2022 09 48 222 2003 075*
			10.0 m	21 03 485 1410 09 48 222 2004 100*	10.0 m	09 47 222 2011 09 48 222 2003 100*
			20.0 m	21 03 485 1420 09 48 222 2004 200*	20.0 m	09 47 222 2013 09 48 222 2003 200*
Open end		1.0 m	21 03 585 1401 09 48 220 0004 010*	1.0 m	09 47 220 0002 09 48 220 0003 010*	
		1.5 m	21 03 585 1451 09 48 220 0004 015*	1.5 m	09 47 220 0003 09 48 220 0003 015*	
		3.0 m	21 03 585 1403 09 48 220 0004 030*	3.0 m	09 47 220 0005 09 48 220 0003 030*	
		5.0 m	21 03 585 1405 09 48 220 0004 050*	5.0 m	09 47 220 0006 09 48 220 0003 050*	
		7.5 m	21 03 585 1457 09 48 220 0004 075*	7.5 m	09 47 220 0022 09 48 220 0003 075*	
		10.0 m	21 03 585 1410 09 48 220 0004 100*	10.0 m	09 47 220 0011 09 48 220 0003 100*	
		20.0 m	21 03 585 1420 09 48 220 0004 200*	20.0 m	09 47 220 0013 09 48 220 0003 200*	

* Mid 2014 the part numbers beginning with 21 03 ... or 09 47 ... will be replaced by the part numbers beginning with 09 48 ... The former part numbers will be set to status inactive. Please use only the part numbers beginning with 09 48 ... for your order.

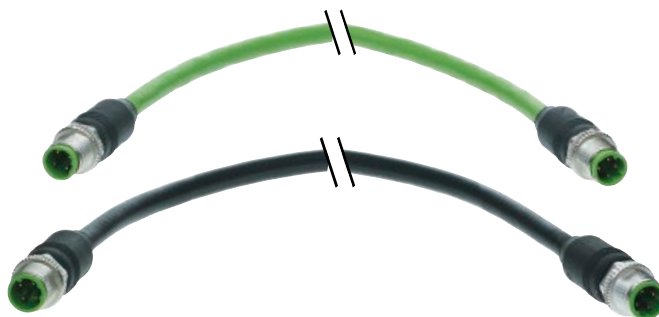
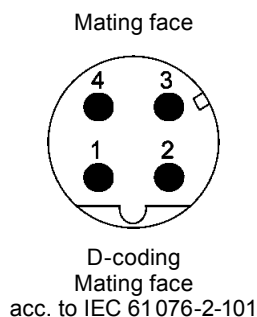

Overview system cables M12

03

		Number of contacts		Male M12 D-coding angled			
				Cable material: PUR		Cable material: PVC	
Male M12	angled		1.0 m	21 03 485 3401 09 48 808 0004 010*	1.0 m	09 47 808 0002 09 48 808 0003 010*	
			1.5 m	21 03 485 3451 09 48 808 0004 015*	1.5 m	09 47 808 0003 09 48 808 0003 015*	
			3.0 m	21 03 485 3403 09 48 808 0004 030*	3.0 m	09 47 808 0005 09 48 808 0003 030*	
			5.0 m	21 03 485 3405 09 48 808 0004 050*	5.0 m	09 47 808 0006 09 48 808 0003 050*	
			7.5 m	21 03 485 3457 09 48 808 0004 075*	7.5 m	09 47 808 0022 09 48 808 0003 075*	
			10.0 m	21 03 485 3410 09 48 808 0004 100*	10.0 m	09 47 808 0011 09 48 808 0003 100*	
			20.0 m	21 03 485 3420 09 48 808 0004 200*	20.0 m	09 47 808 0013 09 48 808 0003 200*	
Open end		1.0 m	21 03 585 3401 09 48 800 0004 010*	1.0 m	09 47 800 0002 09 48 800 0003 010*		
		1.5 m	21 03 585 3451 09 48 800 0004 015*	1.5 m	09 47 800 0003 09 48 800 0003 015*		
		3.0 m	21 03 585 3403 09 48 800 0004 030*	3.0 m	09 47 800 0005 09 48 800 0003 030*		
		5.0 m	21 03 585 3405 09 48 800 0004 050*	5.0 m	09 47 800 0006 09 48 800 0003 050*		
		7.5 m	21 03 585 3457 09 48 800 0004 075*	7.5 m	09 47 800 0022 09 48 800 0003 075*		
		10.0 m	21 03 585 3410 09 48 800 0004 100*	10.0 m	09 47 800 0011 09 48 800 0003 100*		
		20.0 m	21 03 585 3420 09 48 800 0004 200*	20.0 m	09 47 800 0013 09 48 800 0003 200*		

* Mid 2014 the part numbers beginning with 21 03 ... or 09 47 ... will be replaced by the part numbers beginning with 09 48 ... The former part numbers will be set to status inactive. Please use only the part numbers beginning with 09 48 ... for your order.

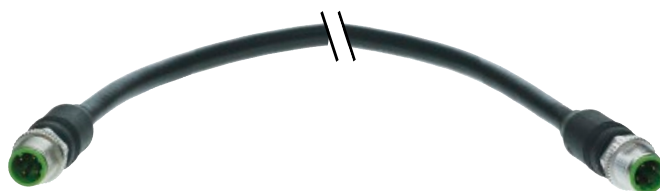

Identification	Part No.	Drawing	Dimensions in mm
<p>2 x M12 Circular connectors, D-coding, PVC, straight</p> <p>Length*: 1.0 m 1.5 m 3.0 m 5.0 m 7.5 m 10.0 m 20.0 m</p>	<p>09 47 222 2002 09 47 222 2003 09 47 222 2005 09 47 222 2006 09 47 222 2022 09 47 222 2011 09 47 222 2013</p>	<p>Cable: AWG 22 / 0.34 mm²</p>	
<p>1 x M12 Circular connectors, D-coding, PVC, straight</p> <p>Length*: 1.0 m 1.5 m 3.0 m 5.0 m 7.5 m 10.0 m 20.0 m</p>	<p>09 47 220 0002 09 47 220 0003 09 47 220 0005 09 47 220 0006 09 47 220 0022 09 47 220 0011 09 47 220 0013</p>	<p>Cable: AWG 22 / 0.34 mm²</p>	
<p>2 x M12 Circular connectors, D-coding, PVC, angled</p> <p>Length*: 1.0 m 1.5 m 3.0 m 5.0 m 7.5 m 10.0 m 20.0 m</p>	<p>09 47 808 0002 09 47 808 0003 09 47 808 0005 09 47 808 0006 09 47 808 0022 09 47 808 0011 09 47 808 0013</p>	<p>Cable: AWG 22 / 0.34 mm²</p>	
<p>1 x M12 Circular connectors, D-coding, PVC, angled</p> <p>Length*: 1.0 m 1.5 m 3.0 m 5.0 m 7.5 m 10.0 m 20.0 m</p>	<p>09 47 800 0002 09 47 800 0003 09 47 800 0005 09 47 800 0006 09 47 800 0022 09 47 800 0011 09 47 800 0013</p>	<p>Cable: AWG 22 / 0.34 mm²</p>	

M12 Panel feed-through HARAX® D-coded



Mating face

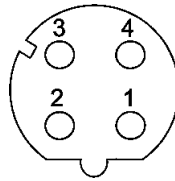

D-coding
Mating face
acc. to IEC 61076-2-101



Identification

Part No.

Drawing

Dimensions in mm

HARAX® Panel feed-through



21 03 381 2425

Female
4 poles, D-coding
0.14 - 0.34 mm² / AWG 26 - 22

Panel thickness
min. 2.5 mm
max. 4.5 mm

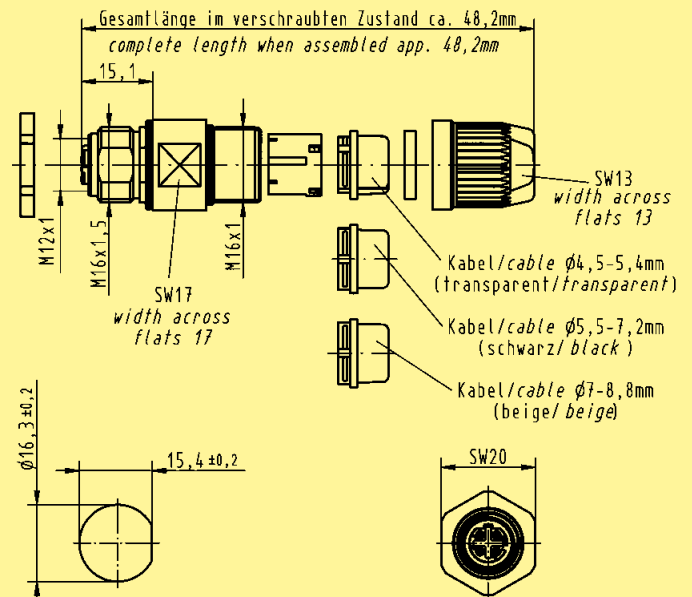

03

M12 Panel feed-through Crimp D-coded



Mating face

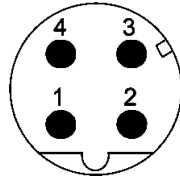

D-coding
Mating face
acc. to IEC 61076-2-101



03

Identification

Part No.

Drawing

Dimensions in mm

M12 Panel feed-through Crimp



21 03 882 1425

Male
4 poles, D-coding

Panel thickness
min. 2.5 mm
max. 4.5 mm

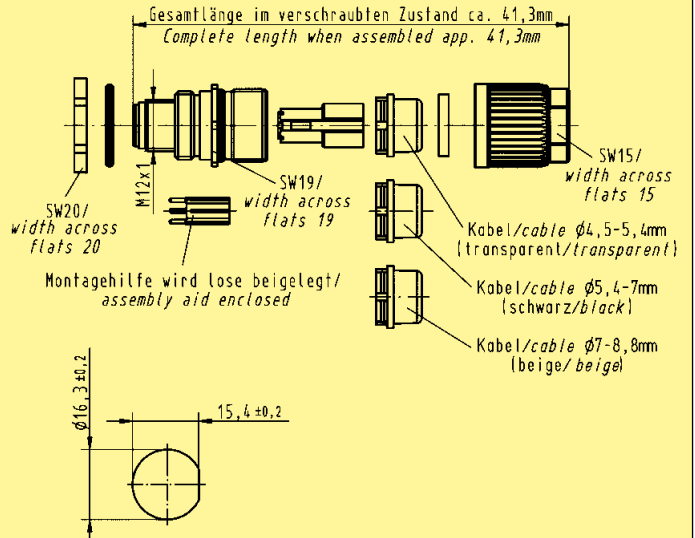

03
80

M12 Panel feed-through Crimp D-coded



Mating face

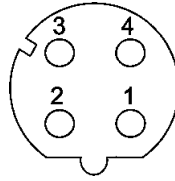

D-coding
Mating face
acc. to IEC 61076-2-101



Identification

Part No.

Drawing

Dimensions in mm

M12 Panel feed-through Crimp



Female
4 poles, D-coding

Panel thickness
min. 2.5 mm
max. 4.5 mm

21 03 882 2425

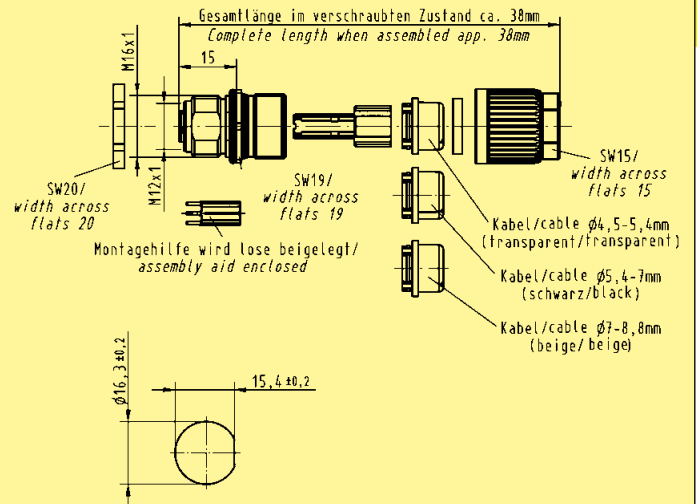

03

M12 Panel feed-through D-coded



Mating face

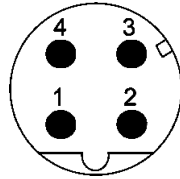

D-coding
Mating face
acc. to IEC 61076-2-101



03

Identification	Part No.	Drawing	Dimensions in mm
----------------	----------	---------	------------------

M12 Panel feed-through



21 03 371 1403

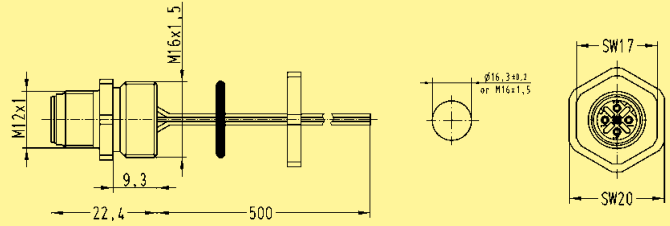

Male
D-coding
50 cm conductors, AWG 22, 4 poles

Panel thickness
min. 2.0 mm
max. 5.0 mm

03
82

M12 Panel feed-through D-coded



Mating face

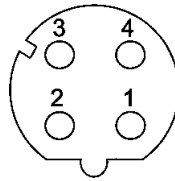

D-coding
Mating face
acc. to IEC 61076-2-101



Identification

Part No.

Drawing

Dimensions in mm

M12 Panel feed-through

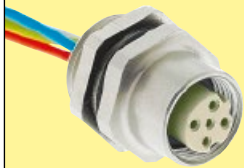

21 03 371 2403

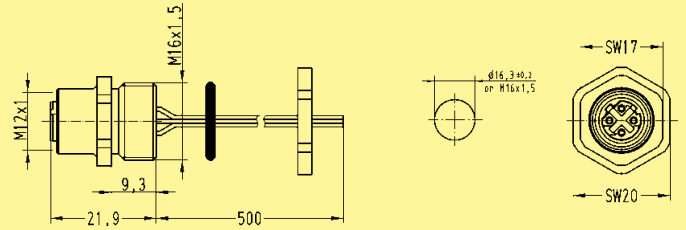

Female
D-coding
50 cm conductors, AWG 22, 4 poles

Panel thickness
min. 2.0 mm
max. 5.0 mm

03

03
83

M12 Panel feed-through D-coded



Mating face

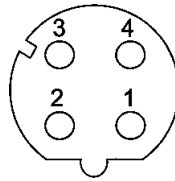

D-coding
Mating face
acc. to IEC 61076-2-101



Identification

Part No.

Drawing

Dimensions in mm

M12 Gender Changer
Female-Female



4 poles, D-coding
Cat. 5

21 03 381 6405

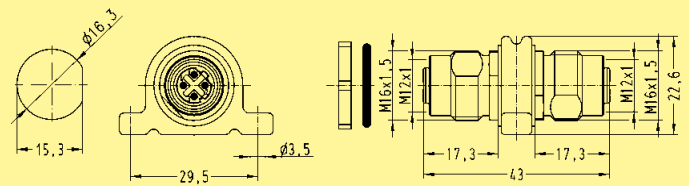

M12 Gender Changer
Female-Female



4 poles, D-coding
Cat. 5

21 03 381 6401*

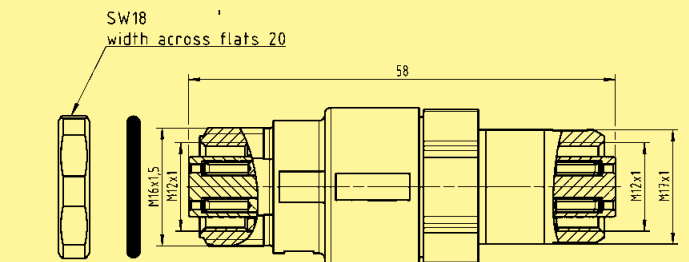

Panel cut out
(1:1)

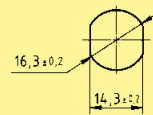

Wall bracket



21 01 000 0036

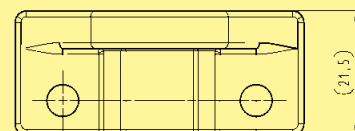
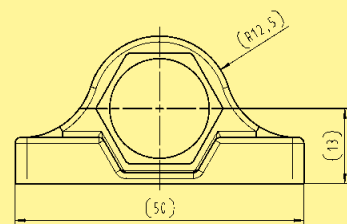

03

03
85

M12 PCB adapter D-coded



Mating face

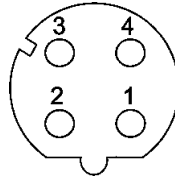

D-coding
Mating face
acc. to IEC 61076-2-101



Identification

Part No.

Drawing

Dimensions in mm

M12 PCB adapter

Female, D-coding,
straight



4 poles, IP67

21 03 371 2415

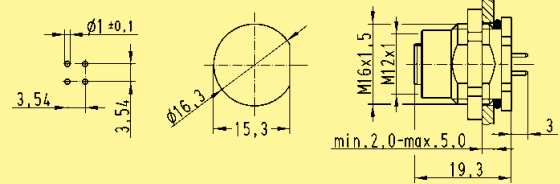

4 poles, IP20
4 poles, IP67

21 03 381 6410
21 03 381 6420

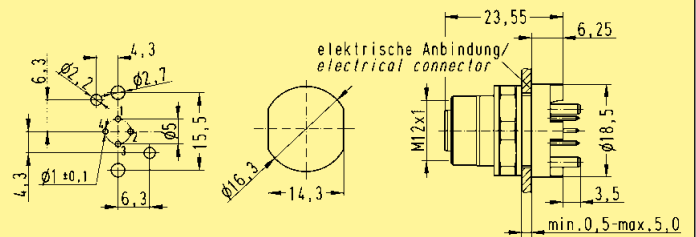

Identification	Part No.	Drawing																								
<p>Crimping tool for M12 Crimp</p>	09 99 000 0501																									
<p>Accessories M12 Crimp</p> <p>Locator</p> <p>D-Sub single contacts (500 mating cycles)</p> <p>turned male contacts AWG 22-18 / 0.33-0.82 mm² AWG 24-20 / 0.25-0.52 mm² AWG 26-22 / 0.13-0.33 mm²</p> <p>turned female contacts AWG 22-18 / 0.33-0.82 mm² AWG 24-20 / 0.25-0.52 mm² AWG 26-22 / 0.13-0.33 mm²</p>	09 99 000 0531	<p>D-Sub contacts</p> <table border="1"> <thead> <tr> <th>Part number</th> <th>AWG</th> <th>Tool settings</th> </tr> </thead> <tbody> <tr> <td rowspan="3">09 67 000 3x76</td> <td>18</td> <td>6</td> </tr> <tr> <td>20</td> <td>6</td> </tr> <tr> <td>22</td> <td>5</td> </tr> <tr> <td>09 67 000 8x76</td> <td>20, 22, 24</td> <td>6</td> </tr> <tr> <td>09 67 000 5x76</td> <td>22, 24, 26</td> <td>6</td> </tr> </tbody> </table> <table border="1"> <thead> <tr> <th></th> <th>a</th> </tr> </thead> <tbody> <tr> <td>AWG 22-18</td> <td>1.34</td> </tr> <tr> <td>AWG 24-20</td> <td>1.13</td> </tr> <tr> <td>AWG 26-22</td> <td>0.88</td> </tr> </tbody> </table>	Part number	AWG	Tool settings	09 67 000 3x76	18	6	20	6	22	5	09 67 000 8x76	20, 22, 24	6	09 67 000 5x76	22, 24, 26	6		a	AWG 22-18	1.34	AWG 24-20	1.13	AWG 26-22	0.88
Part number	AWG	Tool settings																								
09 67 000 3x76	18	6																								
	20	6																								
	22	5																								
09 67 000 8x76	20, 22, 24	6																								
09 67 000 5x76	22, 24, 26	6																								
	a																									
AWG 22-18	1.34																									
AWG 24-20	1.13																									
AWG 26-22	0.88																									
<p>M12 dynamometric screwdriver</p> <p>Tightening torque 0.6 Nm</p> <p>for M12 Slim design SW 15</p> <p>for M12-L SW 17</p>	<p>09 99 000 0646</p> <p>09 99 000 0384</p>																									
<p>Set of seals M12-L shielded</p> <p>for 4.5 - 5.4 mm cable Ø</p> <p>for 5.4 - 7.2 mm cable Ø</p> <p>for 7.2 - 8.8 mm cable Ø</p>	21 01 010 2017																									
<p>Accessories M12</p> <p>Lock nut</p>	21 01 000 0018																									

Identification

Part No.

Drawing

Dimensions in mm

Cap metal M12

for IP65 / IP67
M12 metal cap for male side
with cord

21 01 000 0033

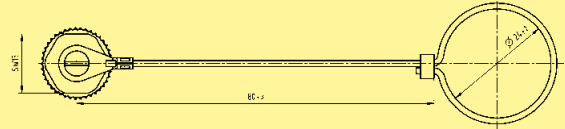

Cap metal M12

for IP65 / IP67
M12 metal cap for male side
with cable clip

21 01 000 0038

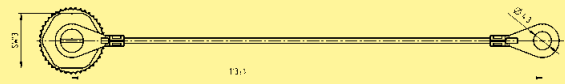

Cap metal M12

for IP65 / IP67
M12 metal cap for female side
with cord

21 01 000 0030

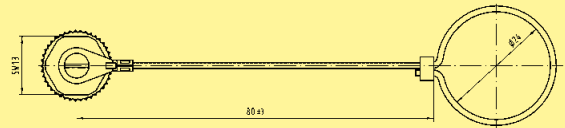

Cap metal M12

for IP65 / IP67
M12 metal cap for female side
with cable clip

21 01 000 0031

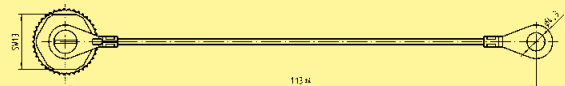

Cap M12

for IP65 / IP67
Seals material Viton
Plastic cap for female



21 01 000 0003

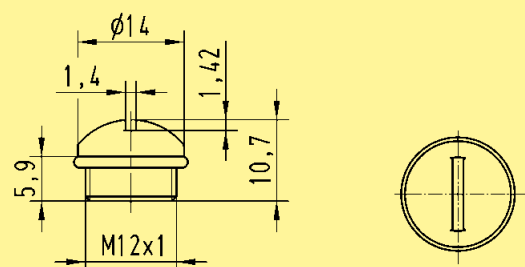

03

03
92

Directory

Page

4. *har*-speed M12 data connectors

4.1 X-coded – Solutions for high-speed applications

o Technical characteristics	04.02
■ Cable connectors	
• <i>har</i> -speed M12 connector	04.05
• System cables	04.06
■ Device connectors	
• <i>har</i> -speed M12 Panel feed-through	04.07
• <i>har</i> -speed PCB connector	04.09
o Accessories	04.13

M12 X-coding



Specifications IEC 60 352-4

Approval 

Mating face

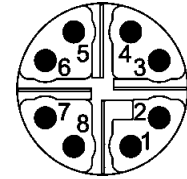

X-coding
Mating face
acc. to IEC 61076-2-101



Technical characteristics M12 – X-coding

Type M12 X-coded	<i>har-speed M12</i> <i>har-speed M12 Slim design</i>
------------------	--

General data

Conductor cross section	0.08 - 0.25 mm ² AWG 28-23
Diameter of individual strands	–
Conductor insulation material	–
Conductor diameter	0.33 - 0.61 mm
Cable diameter	4.5 - 8.8 mm
Temperature range	-40 °C ... +85 °C
Temperature during connection	-5 °C ... +50 °C
Degree of protection	IP65 / IP67
Mating cycles	500
Tightening torque connector / hexagonal wrench	0.6 Nm / SW 15

Electrical characteristics

Rated current	0.5 A
Rated voltage	48 V
Rated impulse voltage	1.5 kV
Contact resistance	15 mΩ
Insulation resistance	10 ⁸ Ω
Pollution degree	3
Overvoltage category	3
Isolation group	1
Transmission performance (Category)	Cat. 6 _A

Materials

Contact material	Brass
Contact plating	Gold
Contact carrier material	LCP
Housing material	ZP410

04

04
02

Technical characteristics M12 – X-coding

Current carrying capacity The current carrying capacity is limited by maximum temperature of materials for inserts and contacts including terminals. The current capacity-curve is valid for continuous, not interrupted current-loaded contacts of connectors when simultaneous power on all contacts is given, without exceeding the maximum temperature.

Control and test procedures according to DIN IEC 60512-5.

har-speed M12
8 poles

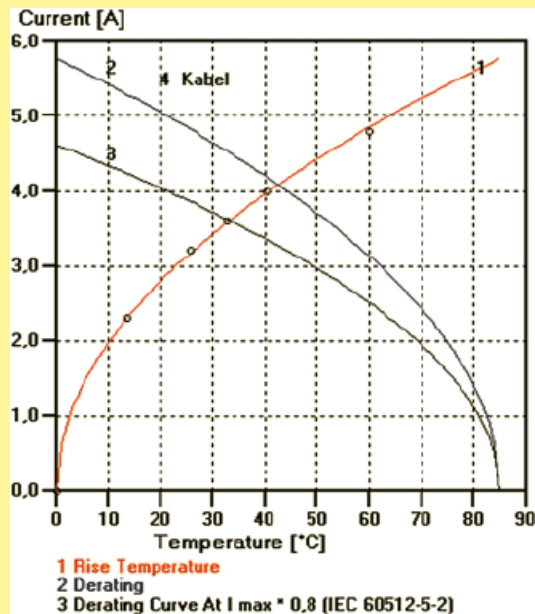

har-speed M12
PCB adapter

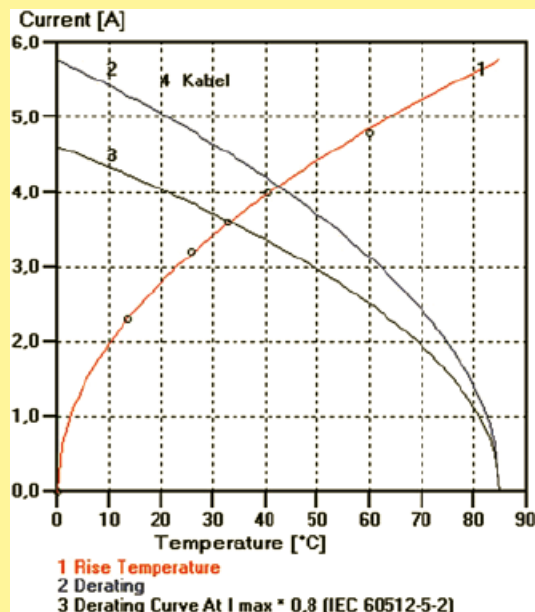

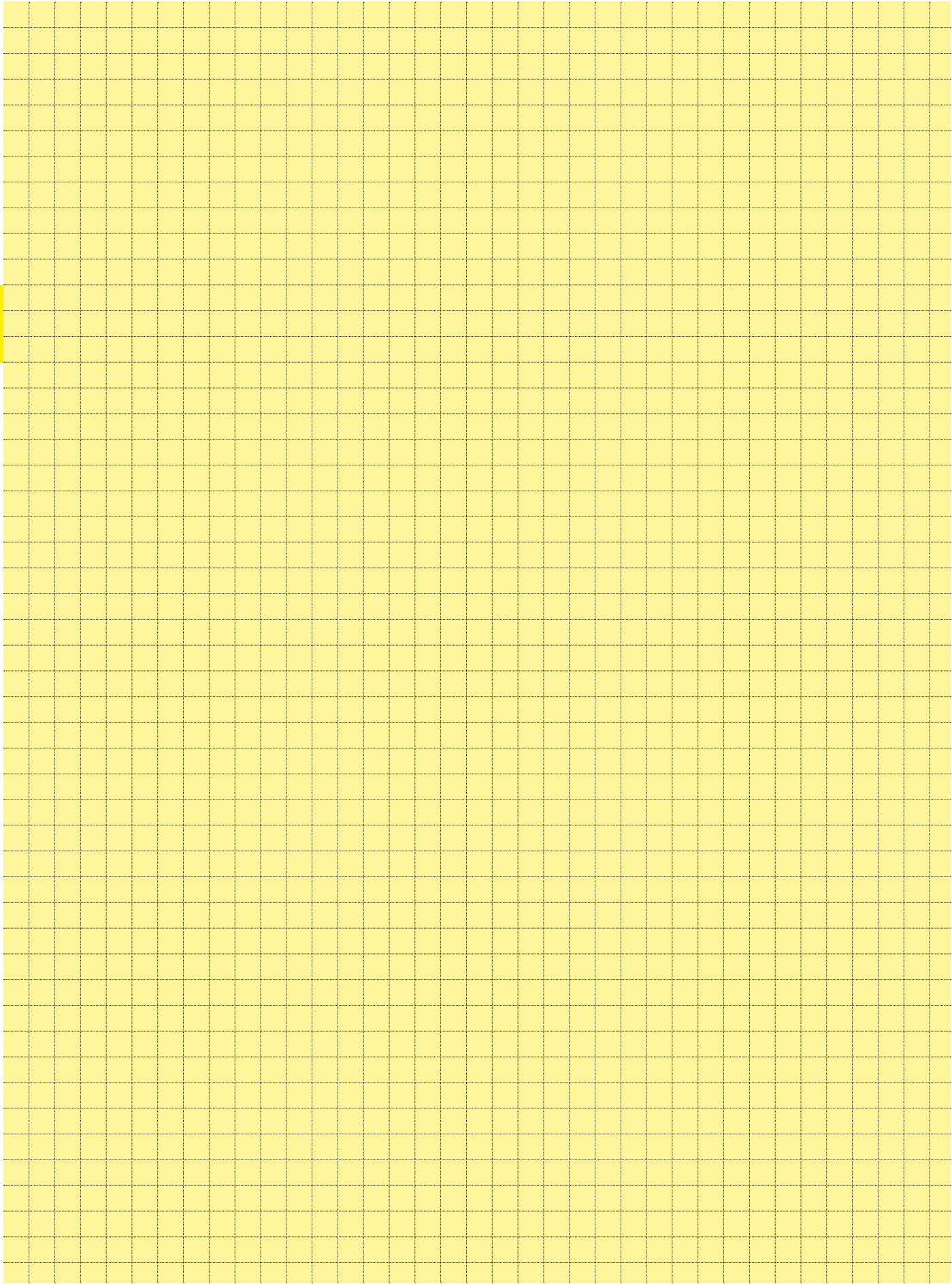



Mating face

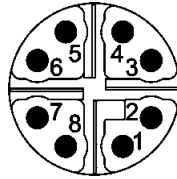

X-coding
Mating face
acc. to IEC 61076-2-101



Applications / Advantages

- High-Speed Ethernet applications for process automatization, e.g. camera system for process control in the production
- Maximum data rates through the configuration of the contacts in conformance with Ethernet technology. Transfer class E_A for 1 and 10 Gigabit
- Perfect shielding through paired shielding of the contacts
- Overmoulded system cables in various lengths

04

Identification

Part No.

Drawing

Dimensions in mm

har-speed M12



Male
straight version
8 poles, Cat. 6_A
Cable diameter: 4.5 - 8.8 mm

21 03 881 5805

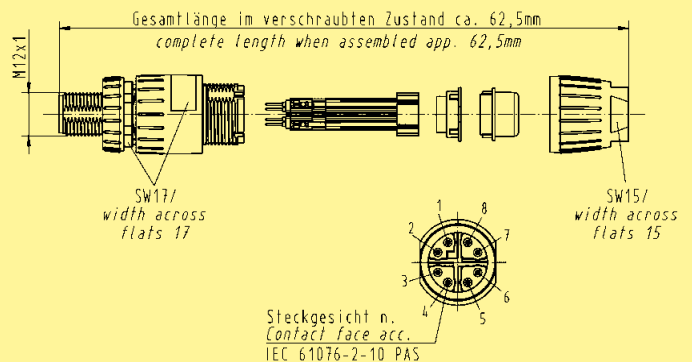

har-speed M12 Slim design



Male
straight version
8 poles, Cat. 6_A
Cable diameter: 4.5 - 8.8 mm

21 03 881 1805

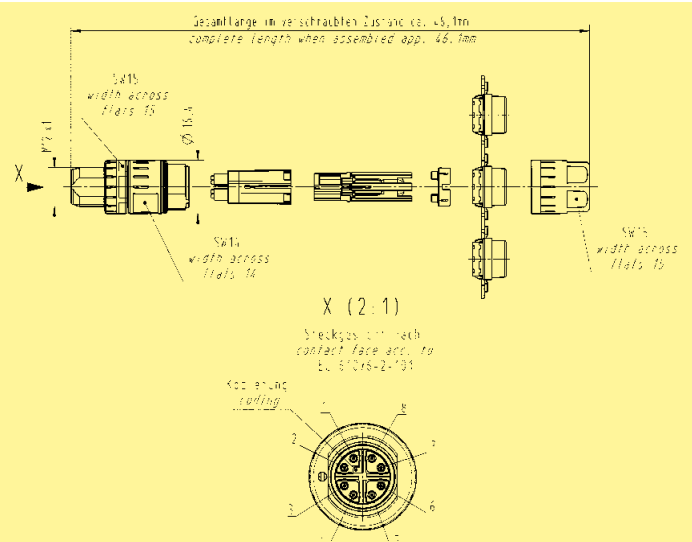

har-speed M12 Panel feed-through X-coded



Mating face

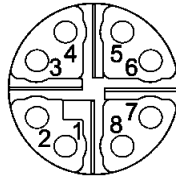

X-coding
Mating face
acc. to IEC 61076-2-101



Identification

Part No.

Drawing

Dimensions in mm

**har-speed M12
Adapter M12-RJ45**



straight, Cat. 6A

Panel thickness
min. 2.1 mm
max. 4.5 mm

21 03 381 2800

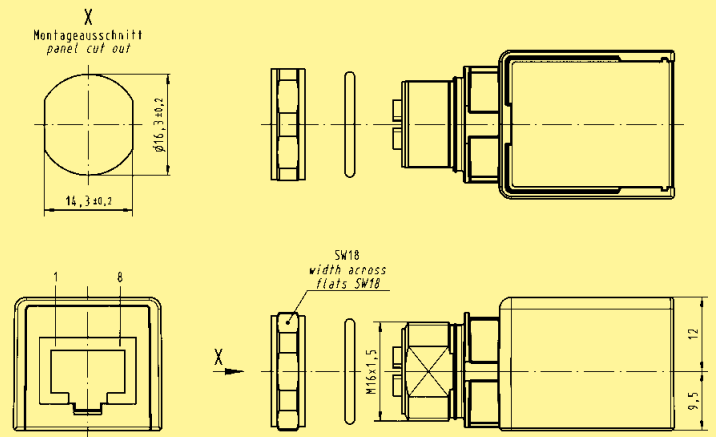

angled, Cat. 6A

Panel thickness
min. 2.1 mm
max. 4.5 mm

21 03 381 4800

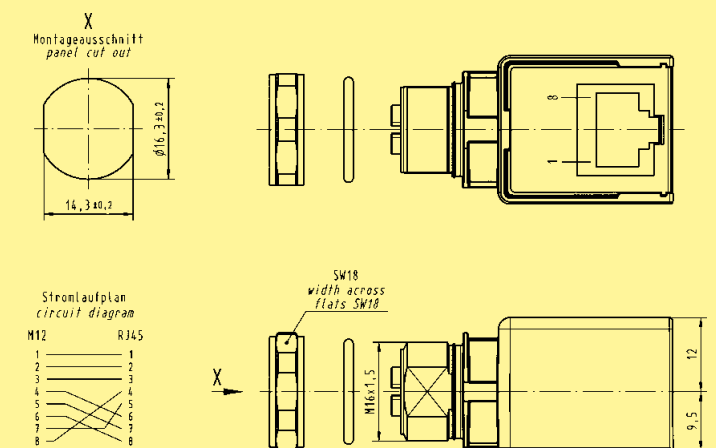

04

04
07

har-speed M12 Panel feed-through X-coded



Mating face

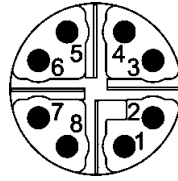

X-coding
Mating face
acc. to IEC 61076-2-101



Identification

Part No.

Drawing

Dimensions in mm

Gender changer, Cat. 6A



21 03 381 6815

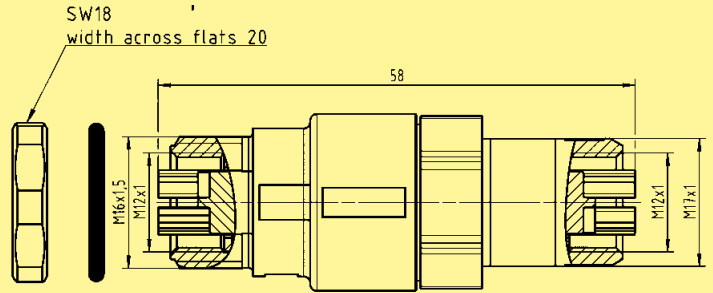

schematic diagram

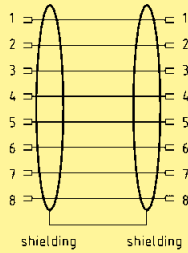

Panel cut out
(1:1)

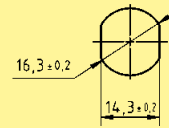

Wall bracket



21 01 000 0036

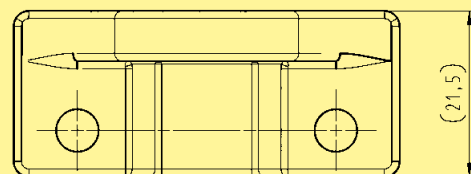
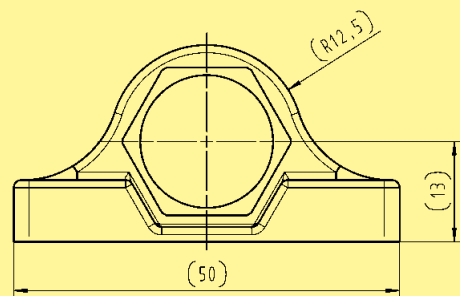

04

04
08

har-speed M12 PCB adapter X-coded



Mating face

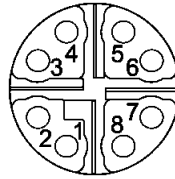

X-coding
Mating face
acc. to IEC 61076-2-101



Identification

Part No.

Drawing

Dimensions in mm

har-speed M12 PCB adapter

Female, X-coding,
straight, Cat. 6_A
for front mounting



21 03 381 2802

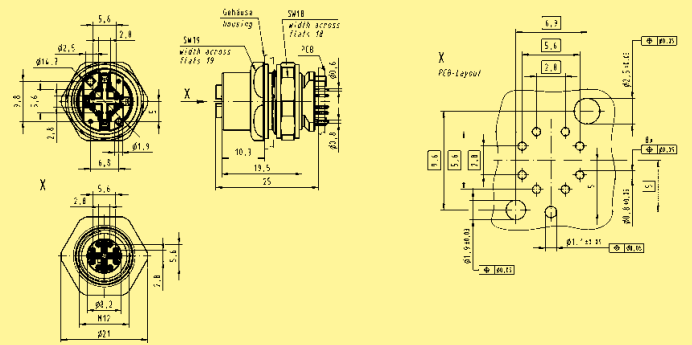

har-speed M12 PCB adapter

Female, X-coding,
straight, Cat. 5
for front mounting



21 03 381 2803

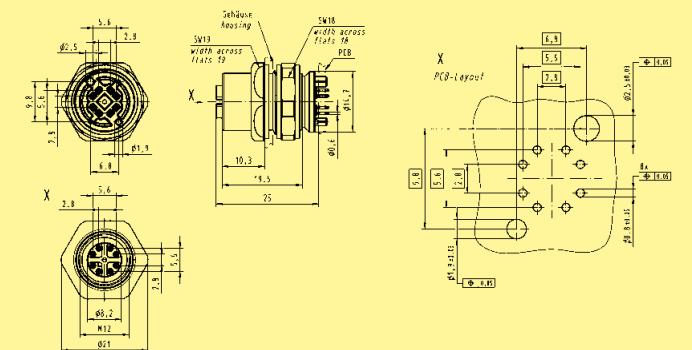

har-speed M12 PCB adapter

Female, X-coding,
angled, Cat. 6_A
for front mounting



21 03 381 4802

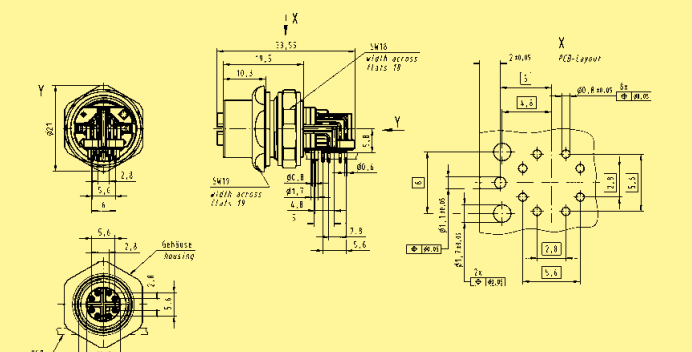

har-speed M12 PCB adapter X-coded



Mating face

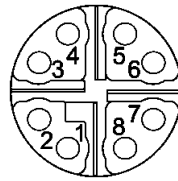

X-coding
Mating face
acc. to IEC 61076-2-101



Identification

Part No.

Drawing

Dimensions in mm

har-speed M12 PCB adapter

Female, X-coding, straight, Cat. 6_A for rear mounting



21 03 381 2804

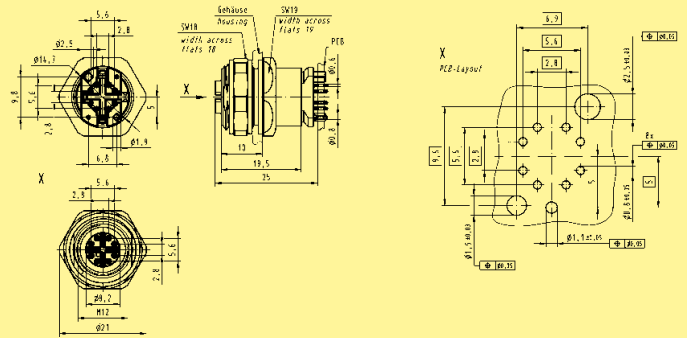

har-speed M12 PCB adapter

Female, X-coding, straight, Cat. 5 for rear mounting



21 03 381 2805

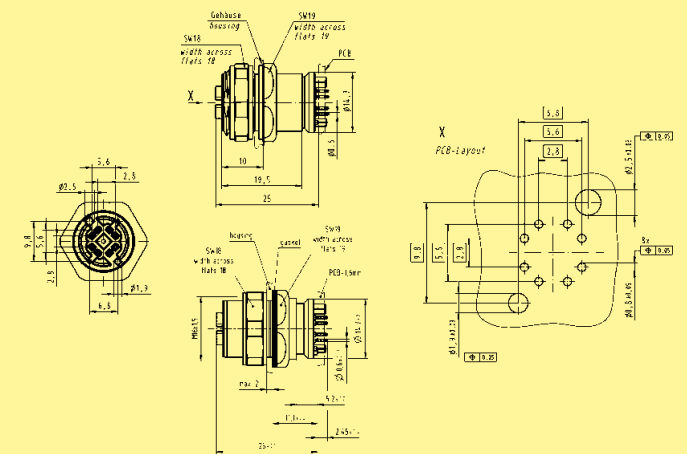

21 03 381 2809

har-speed M12 PCB adapter

Female, X-coding, angled, Cat. 6_A for rear mounting



21 03 381 4804

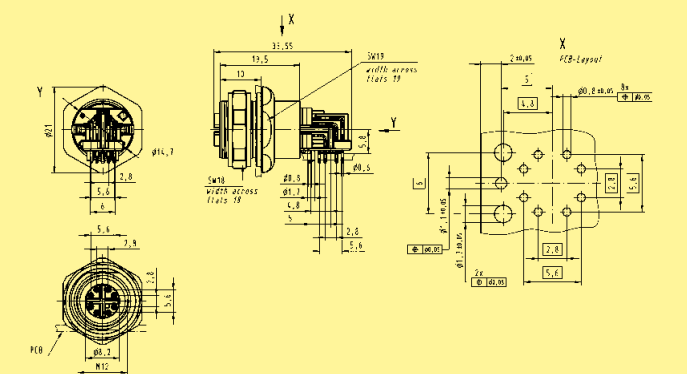

04

04
10

har-speed M12 PCB adapter X-coded



Mating face

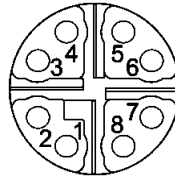

X-coding
Mating face
acc. to IEC 61076-2-101



Identification

Part No.

Drawing

Dimensions in mm

har-speed M12
PCB adapter



Female
8 poles, X-coding
Cat. 6A

21 03 381 2806

Female
8 poles, X-coding
Cat. 5

21 03 381 2807

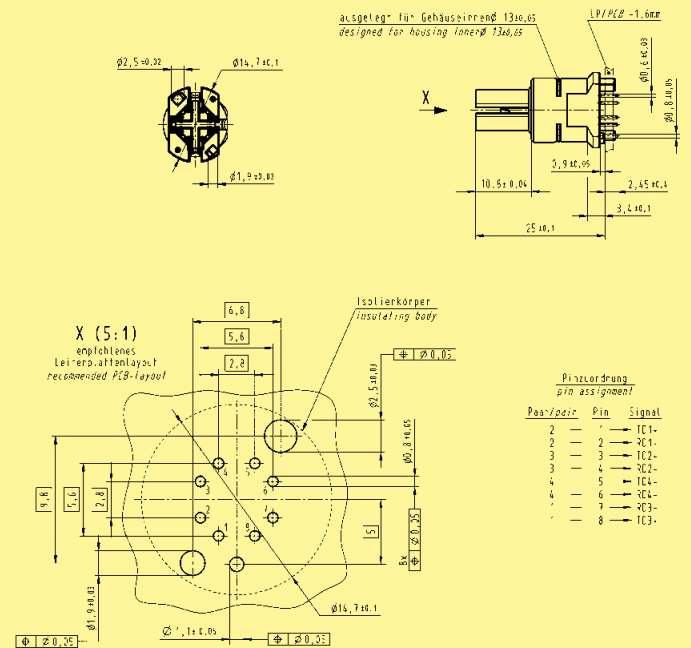

04

Housing



for rear mounting

21 03 301 2000

for front mounting

21 03 301 2001

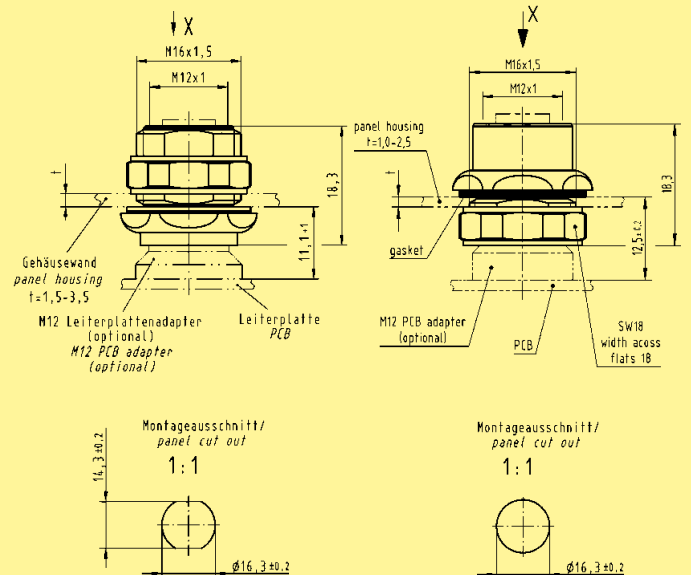

04
11

har-speed M12 PCB adapter X-coded



Mating face

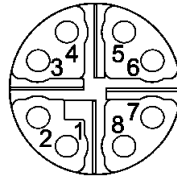

X-coding
Mating face
acc. to IEC 61076-2-101



Identification

Part No.

Drawing

Dimensions in mm

**har-speed M12
PCB adapter**

Female, X-coding,
straight, Cat. 6_A
for front mounting



21 03 381 2801

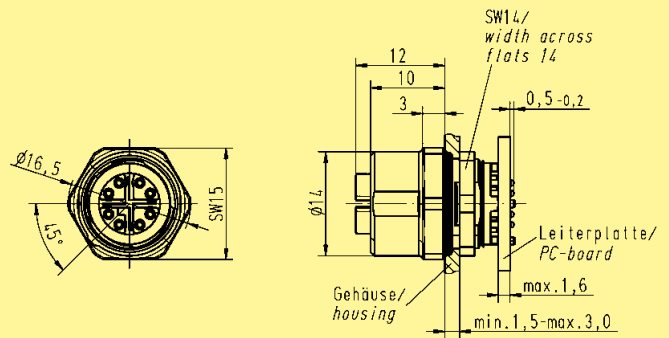

Bohrplan/drilling plan
Bestückungsseite (Frontansicht)
plug-in side (front view)

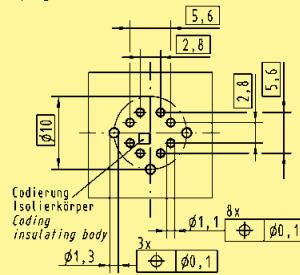

04

04
12

Identification

Part No.

Drawing

Crimping tool
for *har-speed* M12

09 99 000 0501

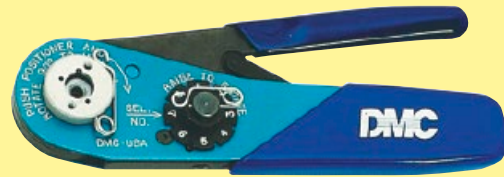

Accessories *har-speed* M12

Locator

09 99 000 0525



Single contacts
(500 mating cycles)

har-speed M12 contacts
AWG 28-24 / 0.08-0.22 mm²



har-speed M12 contacts
AWG 26-23 / 0.13-0.25 mm²

21 01 100 9014

21 01 100 9019

har-speed contacts

Part number	AWG	Tool settings
21 01 100 9014	28	3
	26	4
	24	5
21 01 100 9019	26	4
	24	5
	23	5

Accessories M12

Lock nut

21 01 000 0018



M12
dynamometric screwdriver
Tightening torque 0.6 Nm

for M12 Slim design SW 15

09 99 000 0646



Directory

Page

5. 7/8" HARAX®

5.1 7/8" HARAX®-Power-Circular connectors

o Technical characteristics	05.02
■ Cable connectors	
• 7/8" HARAX® Male	05.04
• 7/8" HARAX® Female	05.05
• System cables	05.06
■ Device connectors	
• Panel feed-through	05.10
o Accessories	05.12

Specifications IEC 60 352-4
DIN 61984

Approval , VDE



Mating face

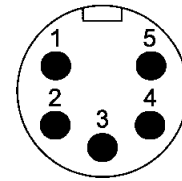

Mating face
acc. to IEC 61076-2-101

Technical characteristics 7/8" HARAX®

Type	7/8" HARAX®
------	-------------

General data

Conductor cross section	0.75 - 1.5 mm ² AWG 18-16
Diameter of individual strands	≥ 0.15 mm
Conductor insulation material	PVC, PP, TPE
Conductor diameter	≤ 2.8 mm
Cable diameter	6.8 - 9.5 mm (black) 9 - 12.5 mm (grey)
Temperature range	-40 °C ... +85 °C
Temperature during connection	-5 °C ... +50 °C
Degree of protection	IP65 / IP67
Mating cycles	100
Recommended tightening torque / Hexagonal wrench	1.5 Nm / SW 22

Electrical characteristics

Rated current	10 A
Rated voltage	230 V / 400 V
Rated impulse voltage	4.8 kV
Contact resistance	10 mΩ
Insulation resistance	10 ⁸ Ω
Pollution degree	3
Overvoltage category	3
Isolation group	1

Materials

Contact material	Copper alloy
Contact plating	Gold
Contact carrier material	TPU, PA
Housing material	TPU, zinc die-cast, PA

Technical characteristics – System cables, 7/8" HARAX®

Degree of protection	IP67
Temperature range	
applies to moved cable	-20 °C ... +80 °C
cables permanently installed	-50 °C ... +80 °C
Rated current	max. 8 A every contact (+40 °C)
Rated voltage	230 / 400 V
Rated impulse voltage	3 kV
Pollution degree	3
Material group	Category I acc. to IEC 60664-1

Cable data

Jacket material	PUR
Jacket colour	grey
Wire isolation	TPM
Wire colours	brown, white, blue, black, green/yellow
Wire gauge	5 x 1.5 mm ²
Standards	UL / CSA

Technical characteristics 7/8" HARAX®

Current carrying capacity The current carrying capacity is limited by maximum temperature of materials for inserts and contacts including terminals. The current capacity-curve is valid for continuous, not interrupted current-loaded contacts of connectors when simultaneous power on all contacts is given, without exceeding the maximum temperature.

Control and test procedures according to DIN IEC 60512-5.

7/8"

1 = Wire gauge 0.75 mm² /
1.5 mm²

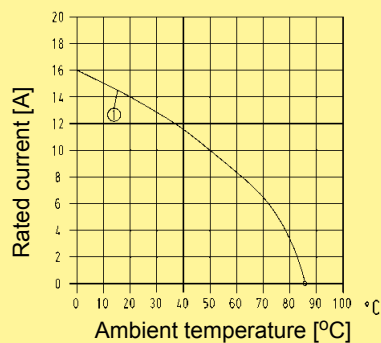



Mating face

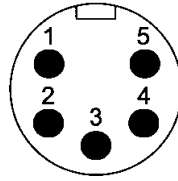

Mating face
acc. to IEC 61076-2-101



Applications / Advantages

- The reliable connector for power applications
- Patent HARAX® fast termination
- Overmoulded system cables in various lengths
- Robust design, quick assembly

05

Identification	Part No.	Drawing	Dimensions in mm
----------------	----------	---------	------------------

7/8" HARAX® Male



21 04 116 1505

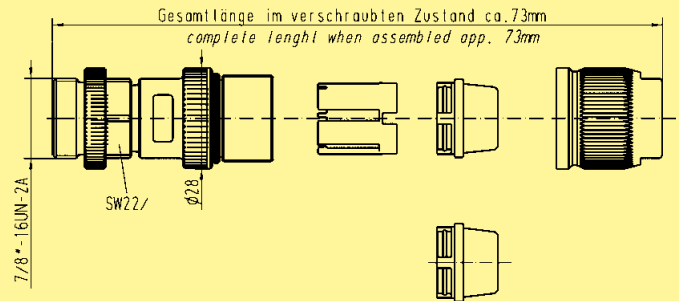



Mating face

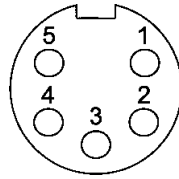

Mating face
acc. to IEC 61076-2-101



Identification

Part No.

Drawing

Dimensions in mm

7/8" HARAX® Female



21 04 116 2505

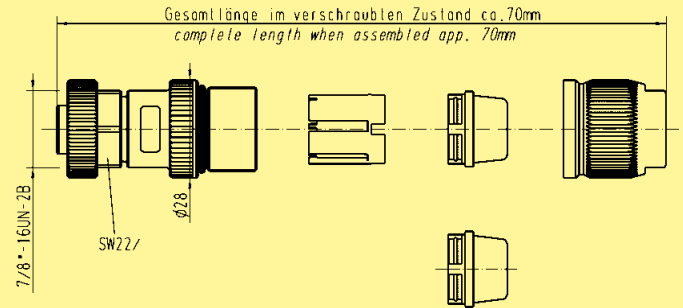

05

05
05

Mating face

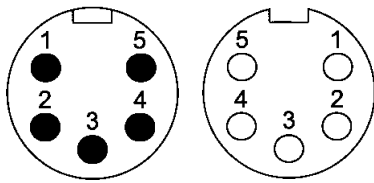

Mating face
acc. to IEC 61076-2-101



Technical characteristics

Degree of protection	IP67
Temperature range	
applies to moved cable	-20 °C ... +80 °C
cables permanently installed	-50 °C ... +80 °C
Rated current	max. 8 A every contact (+40 °C)
Rated voltage	230 / 400 V
Rated impulse voltage	3 kV
Pollution degree	3
Material group	Category I acc. to IEC 60664-1
Cable data	
Jacket material	PUR
Jacket colour	grey
Wire isolation	TPM
Wire colours	brown, white, blue, black, green/yellow
Wire gauge	5 x 1.5 mm ²
Standards	UL / CSA

7/8" System cables



Mating face

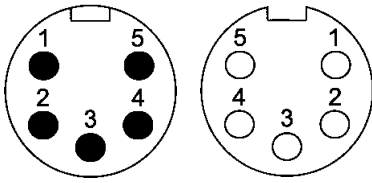

Mating face
acc. to IEC 61076-2-101

Overview system cables 7/8"

		Number of contacts		Male 7/8"			
				straight		angled	
		Cable material: PUR		Cable material: PUR		Cable material: PUR	
Female 7/8"	straight		0.3 m	21 04 416 1501	xxx	xxx	xxx
			0.6 m	21 04 416 1502	xxx	xxx	xxx
			1.0 m	21 04 416 1503	xxx	xxx	xxx
			1.5 m	21 04 416 1504	xxx	xxx	xxx
			2.0 m	21 04 416 1505	xxx	xxx	xxx
	angled		xxx	xxx	0.3 m	21 04 416 3501	xxx
			xxx	xxx	0.6 m	21 04 416 3502	xxx
			xxx	xxx	1.0 m	21 04 416 3503	xxx
			xxx	xxx	1.5 m	21 04 416 3504	xxx
			xxx	xxx	2.0 m	21 04 416 3505	xxx
		Number of contacts		Female 7/8"			
				straight		angled	
		Cable material: PUR		Cable material: PUR		Cable material: PUR	
Open end		1.5 m	21 04 516 2501	1.5 m	21 04 516 4501		
		3.0 m	21 04 516 2502	3.0 m	21 04 516 4502		
		5.0 m	21 04 516 2503	5.0 m	21 04 516 4503		
		7.5 m	21 04 516 2504	7.5 m	21 04 516 4504		
		10.0 m	21 04 516 2505	10.0 m	21 04 516 4505		

7/8" Panel feed-through



Mating face

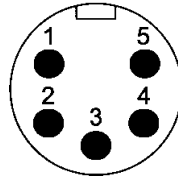

Mating face
acc. to IEC 61076-2-101



Identification

Part No.

Drawing

Dimensions in mm

7/8" Panel feed-through

20 cm conductors, AWG 18, 1 mm², 3 poles

Male

21 04 316 1305

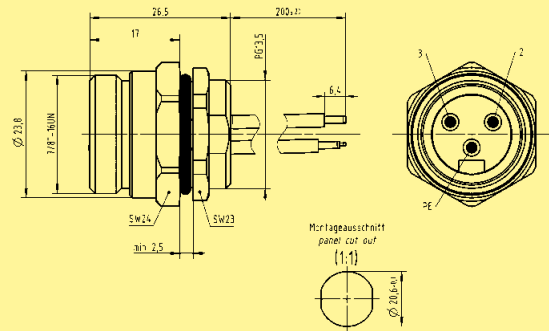

05

7/8" Panel feed-through

50 cm conductors, AWG 18, 1 mm², 5 poles

Male

21 04 316 1505

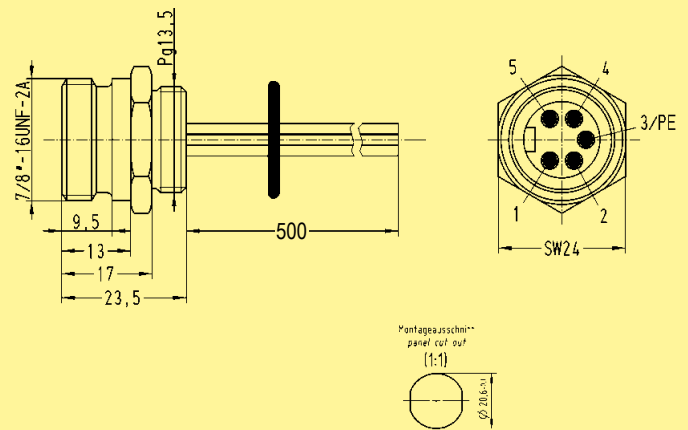

05
10

Identification

Part No.

Drawing

Dimensions in mm

Lock nut Pg 13.5
nickel plated



21 01 000 0020

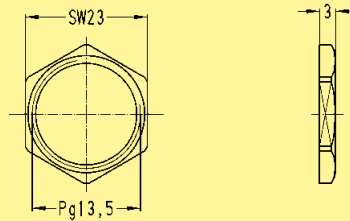

05

7/8"
dynamometric screwdriver
Tightening torque 1.5 Nm

for 7/8"

SW 23

09 99 000 0395

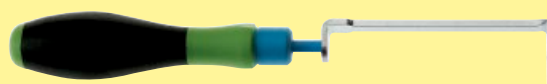

05
12

Directory

Page

6. **HARAX® Panel feed-through**

6.1 **HARAX® Panel feed-through**

o Technical characteristics	06.02
■ Cable connectors	
• HARAX® Pg 13.5 / M20 Panel feed-through	06.04
o Accessories	06.05

HARAX® Panel feed-through



Specifications IEC 60 352-4
DIN 61984

Approval  VDE



Technical characteristics Panel feed-through

Type	HARAX® Pg 13.5/M20 Panel feed-through
-------------	--

General data

Conductor cross section	0.75 - 1.5 mm ² AWG 18 - 16
Diameter of individual strands	≥ 0.2 mm
Conductor insulation material	PVC, PP, TPE
Conductor diameter	≤ 2.8 mm
Cable diameter	6 - 9 mm
Temperature range	-25 °C ... +85 °C
Temperature during connection	-5 °C ... +50 °C
Degree of protection	IP67
Mating cycles	100
Recommended tightening torque	8 Nm

Electrical characteristics

Rated current	16 A
Rated voltage	230 V / 400 V
Rated impulse voltage	4 KV
Contact resistance	10 mΩ
Insulation resistance	10 ⁸ Ω
Pollution degree	3
Overvoltage category	3
Isolation group	1

Materials

Contact material	Copper alloy
Contact plating	Gold
Contact carrier material	TPU, PA
Housing material	TPU, PA

06

06
02

Technical characteristics Panel feed-through

Current carrying capacity The current carrying capacity is limited by maximum temperature of materials for inserts and contacts including terminals. The current capacity-curve is valid for continuous, not interrupted current-loaded contacts of connectors when simultaneous power on all contacts is given, without exceeding the maximum temperature.

Control and test procedures according to DIN IEC 60 512-5.

Pg 13.5
3 poles

1 = Wire gauge
0.75 mm²

2 = Wire gauge
1.5 mm²

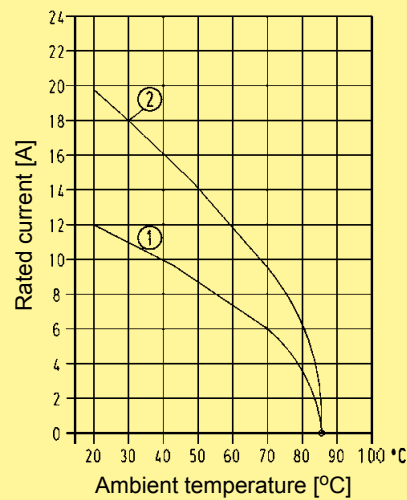

Pg 13.5 / M20
4 poles

1 = Wire gauge
0.75 mm²

2 = Wire gauge
1.5 mm²

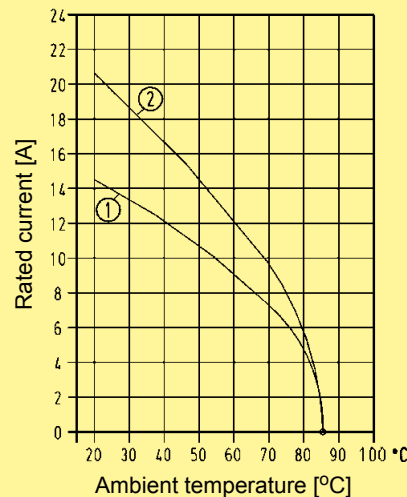

HARAX® Pg 13.5 / M20 Panel feed-through

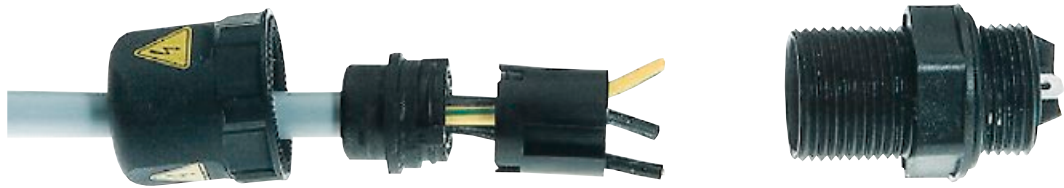

Identification	Part No.	Drawing	Dimensions in mm
HARAX® Pg 13.5 / 3 contacts with faston blades	21 01 130 1013		Pg 13.5 14,5
HARAX® Pg 13.5 / 3 contacts with solder termination	21 01 130 1023		
HARAX® Pg 13.5 / 3 contacts with pre-assembled pigtail cable, l = 500 mm, 1.5 mm ²	21 01 130 1223		
HARAX® Pg 13.5 / 2 + PE with faston blades	21 01 130 3013		Pg 13.5 14,5
HARAX® Pg 13.5 / 2 + PE with solder termination	21 01 130 3023		
HARAX® Pg 13.5 / 2 + PE with pre-assembled pigtail cable, l = 500 mm, 1.5 mm ²	21 01 130 3233		
HARAX® Pg 13.5 / 4 contacts with solder termination	21 01 140 1023		Pg 13.5 12,9
HARAX® Pg 13.5 / 3 + PE with solder termination	21 01 140 3023		
HARAX® Pg 13.5 / 4 contacts with pre-assembled pigtail cable, l = 500 mm, 1.5 mm ²	21 01 140 1323		
HARAX® Pg 13.5 / 3 + PE with pre-assembled pigtail cable, l = 500 mm, 1.5 mm ²	21 01 140 3333		
HARAX® M20 / 4 contacts with solder termination	21 01 141 1023		M20x1,5 12,9
HARAX® M20 / 3 + PE with solder termination	21 01 141 3023		
HARAX® M20 / 4 contacts with pre-assembled pigtail cable, l = 500 mm, 1.5 mm ²	21 01 141 1323		
HARAX® M20 / 3 + PE with pre-assembled pigtail cable, l = 500 mm, 1.5 mm ²	21 01 141 3333		

06

06
04

Identification	Part No.	Drawing	Dimensions in mm
<p>Termination element M12 HARAX® Pg 9 3 contacts Screw cap, splice ring, seal</p>	<p>21 01 010 0001</p>		
<p>Termination element M12 HARAX® Pg 9 4 contacts Screw cap, splice ring, seal</p>	<p>21 01 010 0006</p>		
<p>Lock nut Pg 9</p> <p>Lock nut Pg 13.5, SW 27</p> <p>Lock nut Pg 13.5, SW 24</p>	<p>21 01 000 0008</p> <p>21 01 000 0007</p> <p>21 01 000 0039</p>		



Directory

Page

7. INOX – Solutions for extreme demands

7.1 M12 INOX

o Technical characteristics	07.02
■ Cable connectors	
• M12-L INOX	07.04

M12 INOX



Specifications IEC 60 352-4
IEC 60 068-2-52:1996, severity level 4



Technical characteristics M12 INOX

Type M12 INOX V4A	HARAX® M12-L 4 poles	M12 Crimp
-------------------	-------------------------	-----------

General data

Conductor cross section	0.34 - 0.75 mm ² AWG 22 - 18	0.14 - 0.75 mm ² AWG 26 - 18
Diameter of individual strands	≥ 0.1 mm	X
Conductor insulation material	PVC	X
Conductor diameter	1.6 - 2.0 mm 2.0 - 2.6 mm	2.0 - 2.3 mm
Cable diameter	6 - 8 mm	4.5 - 8.8 mm
Temperature range	-40 °C ... +85 °C	-40 °C ... +85 °C
Temperature during connection	-5 °C ... +50 °C	-5 °C ... +50 °C
Degree of protection	IP65 / IP67	IP67
Mating cycles	100	500
Tightening torque connector / hexagonal wrench	0.6 Nm / SW 17	0.6 Nm / SW 17

Electrical characteristics

Rated current	6 A	4 A
Rated voltage	50 V	250 V
Rated impulse voltage	1.5 kV	1.5 kV
Contact resistance	10 mΩ	10 mΩ
Insulation resistance	10 ⁸ Ω	10 ⁸ Ω
Pollution degree	3	3
Overvoltage category	3	3
Isolation group	1	1

Materials

Contact material	Brass	Brass
Contact plating	Gold	Gold
Contact carrier material	PA unreinforced	PA
Housing material	V4A	V4A

07

07
02

Technical characteristics M12 INOX

Current carrying capacity The current carrying capacity is limited by maximum temperature of materials for inserts and contacts including terminals. The current capacity-curve is valid for continuous, not interrupted current-loaded contacts of connectors when simultaneous power on all contacts is given, without exceeding the maximum temperature.

Control and test procedures according to DIN IEC 60 512-5.

M12-L
4 poles

1 = Wire gauge 0.34 mm²
2 = Wire gauge 0.75 mm²

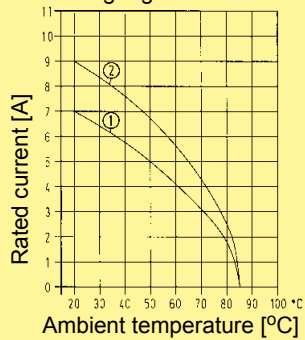

M12, Crimp 1 = Wire gauge 0.34 mm² /
0.5 mm²

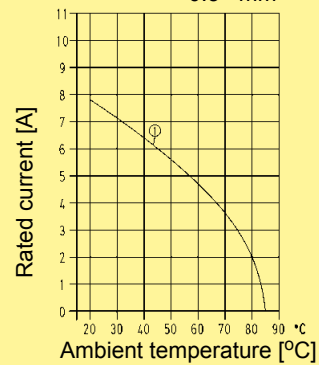



Mating faces

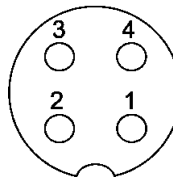

A-coding
4 poles
Mating faces acc. to IEC 61076-2-101

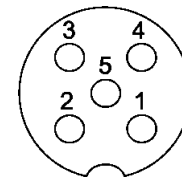



A-coding
5 poles
Mating faces acc. to IEC 61076-2-101



Applications / Advantages

- Designed for rough outdoor applications in harsh environments
- Material V4A
- Available with crimp resp. **HARAX®** rapid termination
- Extreme robust design, quick assembly

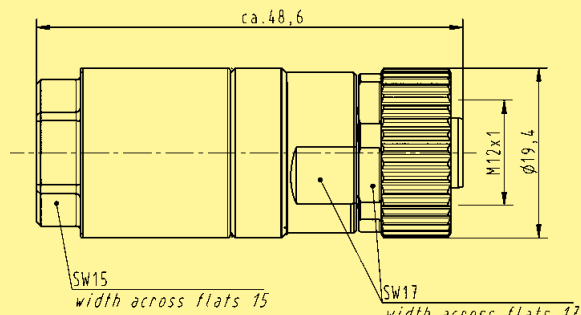
07

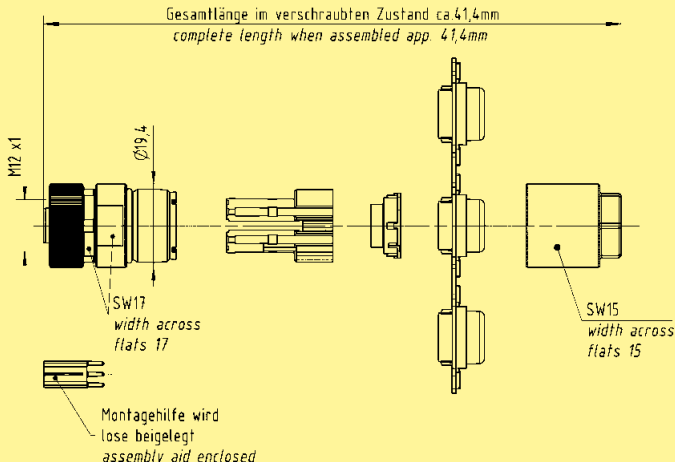
Identification	Part No.	Drawing	Dimensions in mm
<p>HARAX® M12-L INOX</p>  <p>Female, A-coding, straight version 4 poles</p>	21 03 222 2435		
<p>M12-L Crimp INOX</p>  <p>Female, A-coding, straight version 5 poles</p>	21 03 822 2535		

07
04



Mating faces

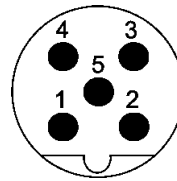

B-coding

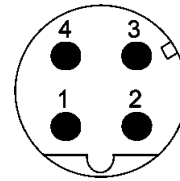

D-coding

Mating faces acc. to IEC 61076-2-101



Identification

Part No.

Drawing

Dimensions in mm

M12-L Crimp INOX



Male, B-coding,
straight version
5 poles

21 03 841 1535

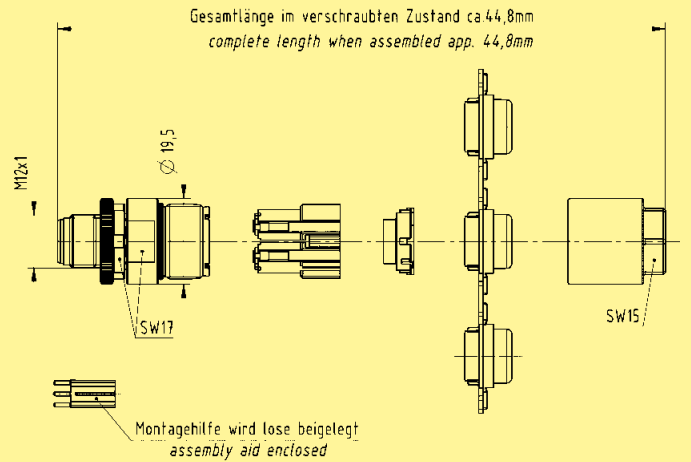

Male, D-coding,
straight version
4 poles

21 03 882 1435

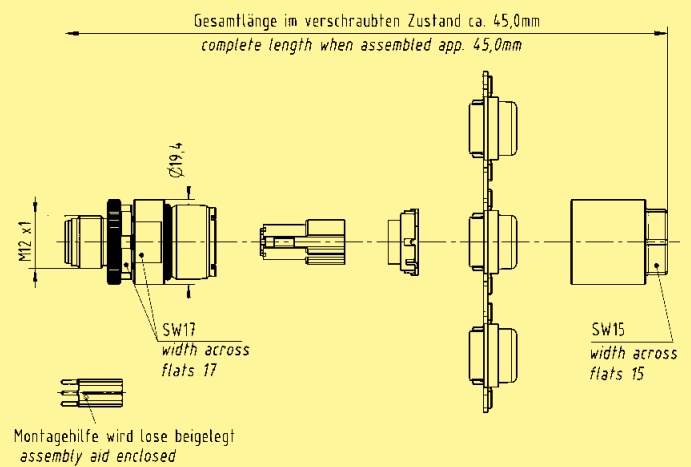

List of part numbers



Part No.	Page	Part No.	Page	Part No.	Page	Part No.	Page	Part No.	Page
09 47 220 0002	03.74	09 48 220 0004 075	03.74	09 99 000 0382	03.60	21 01 010 2017	03.62	21 02 554 7305	02.09
09 47 220 0002	03.77	09 48 220 0004 100	03.74	09 99 000 0384	03.36	21 01 010 2017	03.91	21 02 554 7305	02.11
09 47 220 0003	03.74	09 48 220 0004 200	03.74	09 99 000 0384	03.60				
09 47 220 0003	03.77			09 99 000 0384	03.91	21 01 100 9014	04.13		
09 47 220 0005	03.74	09 48 222 2003 010	03.74	09 99 000 0395	05.12	21 01 100 9019	04.13	21 03 030 1300	03.62
09 47 220 0005	03.77	09 48 222 2003 015	03.74	09 99 000 0501	03.36			21 03 030 1400	03.36
09 47 220 0006	03.74	09 48 222 2003 030	03.74	09 99 000 0501	03.60				
09 47 220 0006	03.77	09 48 222 2003 050	03.74	09 99 000 0501	03.91	21 01 130 1013	06.04		
09 47 220 0011	03.74	09 48 222 2003 075	03.74	09 99 000 0501	04.13	21 01 130 1023	06.04	21 03 111 1405	03.08
09 47 220 0011	03.77	09 48 222 2003 100	03.74	09 99 000 0525	04.13	21 01 130 1223	06.04	21 03 111 2405	03.09
09 47 220 0013	03.74	09 48 222 2003 100	03.74	09 99 000 0531	03.36	21 01 130 3013	06.04		
09 47 220 0013	03.77	09 48 222 2003 200	03.74	09 99 000 0531	03.60	21 01 130 3023	06.04	21 03 112 1405	03.08
09 47 220 0022	03.74	09 48 222 2004 010	03.74	09 99 000 0531	03.91	21 01 130 3233	06.04	21 03 112 2405	03.09
09 47 220 0022	03.77	09 48 222 2004 015	03.74	09 99 000 0646	03.36				
		09 48 222 2004 030	03.74	09 99 000 0646	03.91				
		09 48 222 2004 050	03.74	09 99 000 0646	04.13	21 01 140 1023	06.04	21 03 121 1801	03.14
09 47 222 2002	03.74	09 48 222 2004 075	03.74			21 01 140 1323	06.04	21 03 121 2801	03.15
09 47 222 2002	03.77	09 48 222 2004 100	03.74			21 01 140 3023	06.04		
09 47 222 2003	03.74	09 48 222 2004 200	03.74			21 01 140 3333	06.04		
09 47 222 2003	03.77					21 01 140 5081	03.10	21 03 212 1305	03.12
09 47 222 2005	03.74	09 48 800 0003 010	03.75	20 82 000 0001	03.71	21 01 140 5091	03.11	21 03 212 1306	03.12
09 47 222 2005	03.77	09 48 800 0003 015	03.75	20 82 000 0003	03.71			21 03 212 1400	03.12
09 47 222 2006	03.74	09 48 800 0003 030	03.75	20 82 000 1210	03.71	21 01 141 1023	06.04	21 03 212 1407	03.12
09 47 222 2006	03.77	09 48 800 0003 050	03.75	20 82 000 9901	03.71	21 01 141 1323	06.04	21 03 212 2305	03.13
09 47 222 2011	03.74	09 48 800 0003 075	03.75			21 01 141 3023	06.04	21 03 212 2306	03.13
09 47 222 2011	03.77	09 48 800 0003 100	03.75			21 01 141 3333	06.04	21 03 212 2400	03.13
09 47 222 2013	03.74	09 48 800 0003 200	03.75	20 82 005 1214	03.71			21 03 212 2407	03.13
09 47 222 2013	03.77	09 48 800 0004 010	03.75						
09 47 222 2022	03.74	09 48 800 0004 015	03.75			21 02 151 1305	02.06	21 03 221 1405	03.14
09 47 222 2022	03.77	09 48 800 0004 030	03.75			21 02 151 1405	02.06	21 03 221 2405	03.15
		09 48 800 0004 050	03.75			21 02 151 2305	02.07		
		09 48 800 0004 075	03.75	21 01 000 0003	03.37	21 02 151 2405	02.07		
09 47 800 0002	03.75	09 48 800 0004 100	03.75	21 01 000 0003	03.60			21 03 222 2435	07.04
09 47 800 0002	03.77	09 48 800 0004 200	03.75	21 01 000 0003	03.92	21 02 159 1305	02.05		
09 47 800 0003	03.75			21 01 000 0003	04.14			21 03 241 1301	03.42
09 47 800 0003	03.77			21 01 000 0007	06.05			21 03 241 2301	03.43
09 47 800 0005	03.75	09 48 808 0003 010	03.75	21 01 000 0008	06.05	21 02 454 5301	02.09		
09 47 800 0005	03.77	09 48 808 0003 015	03.75	21 01 000 0018	03.37	21 02 454 5301	02.10		
09 47 800 0006	03.75	09 48 808 0003 030	03.75	21 01 000 0018	03.62	21 02 454 5302	02.09	21 03 272 1505	03.12
09 47 800 0006	03.77	09 48 808 0003 050	03.75	21 01 000 0018	03.91	21 02 454 5302	02.10	21 03 272 2505	03.13
09 47 800 0011	03.75	09 48 808 0003 075	03.75	21 01 000 0018	04.13	21 02 454 5303	02.09		
09 47 800 0011	03.77	09 48 808 0003 100	03.75	21 01 000 0020	05.12	21 02 454 5303	02.10	21 03 281 1405	03.66
09 47 800 0013	03.75	09 48 808 0003 200	03.75	21 01 000 0030	03.38	21 02 454 5304	02.09	21 03 281 2405	03.67
09 47 800 0013	03.77	09 48 808 0004 010	03.75	21 01 000 0030	03.61	21 02 454 5304	02.10		
09 47 800 0022	03.75	09 48 808 0004 015	03.75	21 01 000 0030	03.92	21 02 454 5305	02.09	21 03 282 1405	03.66
09 47 800 0022	03.77	09 48 808 0004 030	03.75	21 01 000 0030	04.14	21 02 454 5305	02.10	21 03 282 2405	03.67
		09 48 808 0004 050	03.75	21 01 000 0031	03.38	21 02 454 7301	02.09		
		09 48 808 0004 075	03.75	21 01 000 0031	03.61	21 02 454 7301	02.10		
09 47 808 0002	03.75	09 48 808 0004 100	03.75	21 01 000 0031	03.92	21 02 454 7302	02.09	21 03 301 1000	03.34
09 47 808 0002	03.77	09 48 808 0004 200	03.75	21 01 000 0031	04.14	21 02 454 7302	02.10	21 03 301 1000	03.58
09 47 808 0003	03.75			21 01 000 0033	03.38	21 02 454 7303	02.09	21 03 301 1000	03.89
09 47 808 0003	03.77			21 01 000 0033	03.61	21 02 454 7303	02.10	21 03 301 1001	03.34
09 47 808 0005	03.75			21 01 000 0033	03.92	21 02 454 7304	02.09	21 03 301 1001	03.58
09 47 808 0005	03.77	09 67 000 3476	03.36	21 01 000 0033	04.14	21 02 454 7304	02.10	21 03 301 1001	03.89
09 47 808 0006	03.75	09 67 000 3476	03.60	21 01 000 0036	03.85	21 02 454 7305	02.09	21 03 301 2000	03.35
09 47 808 0006	03.77	09 67 000 3476	03.91	21 01 000 0036	04.08	21 02 454 7305	02.10	21 03 301 2000	03.59
09 47 808 0011	03.75	09 67 000 3576	03.36	21 01 000 0038	03.38			21 03 301 2000	03.90
09 47 808 0011	03.77	09 67 000 3576	03.60	21 01 000 0038	03.61			21 03 301 2000	04.11
09 47 808 0013	03.75	09 67 000 3576	03.91	21 01 000 0038	03.92	21 02 554 4301	02.09	21 03 301 2001	03.35
09 47 808 0013	03.77	09 67 000 5476	03.36	21 01 000 0038	04.14	21 02 554 4301	02.11	21 03 301 2001	03.59
09 47 808 0022	03.75	09 67 000 5476	03.60	21 01 000 0039	06.05	21 02 554 4302	02.09	21 03 301 2001	03.90
09 47 808 0022	03.77	09 67 000 5476	03.91			21 02 554 4302	02.11	21 03 301 2001	04.11
		09 67 000 5576	03.36			21 02 554 4303	02.09		
		09 67 000 5576	03.60	21 01 010 0001	06.05	21 02 554 4303	02.11		
		09 67 000 5576	03.91	21 01 010 0006	06.05	21 02 554 4304	02.09	21 03 311 1402	03.30
09 48 220 0003 010	03.74	09 67 000 8476	03.36	21 01 010 2001	03.37	21 02 554 4304	02.11	21 03 311 1501	03.30
09 48 220 0003 015	03.74	09 67 000 8476	03.60	21 01 010 2005	02.12	21 02 554 4305	02.09	21 03 311 2400	03.31
09 48 220 0003 030	03.74	09 67 000 8476	03.91	21 01 010 2007	03.37	21 02 554 4305	02.11	21 03 311 2501	03.31
09 48 220 0003 050	03.74	09 67 000 8576	03.36	21 01 010 2007	03.62	21 02 554 7301	02.09	21 03 311 2801	03.33
09 48 220 0003 075	03.74	09 67 000 8576	03.60	21 01 010 2008	02.12	21 02 554 7301	02.11		
09 48 220 0003 100	03.74	09 67 000 8576	03.91	21 01 010 2011	03.37	21 02 554 7302	02.09	21 03 321 1410	03.32
09 48 220 0003 200	03.74			21 01 010 2013	02.12	21 02 554 7302	02.11	21 03 321 1420	03.32
09 48 220 0004 010	03.74			21 01 010 2015	03.37	21 02 554 7303	02.09	21 03 321 1425	03.26
09 48 220 0004 015	03.74			21 01 010 2015	03.62	21 02 554 7303	02.11	21 03 321 1510	03.32
09 48 220 0004 030	03.74	09 99 000 0380	02.12	21 01 010 2016	02.12	21 02 554 7304	02.09	21 03 321 1518	03.34
09 48 220 0004 050	03.74	09 99 000 0382	03.36	21 01 010 2017	03.37	21 02 554 7304	02.11	21 03 321 1520	03.32

Be

List of part numbers



Part No.	Page	Part No.	Page	Part No.	Page	Part No.	Page	Part No.	Page
21 03 321 1818	03.34	21 03 415 5401	03.23	21 03 485 3410	03.76	21 03 549 4304	03.49	21 04 316 1305	05.10
21 03 321 2425	03.27	21 03 415 5402	03.21	21 03 485 3420	03.75	21 03 549 4305	03.47	21 04 316 1505	05.10
21 03 321 2518	03.35	21 03 415 5402	03.23	21 03 485 3420	03.76	21 03 549 4305	03.49	21 04 316 2400	05.11
21 03 321 2818	03.35	21 03 415 5403	03.21	21 03 485 3451	03.75			21 04 316 2505	05.11
21 03 321 6410	03.33	21 03 415 5403	03.23	21 03 485 3451	03.76	21 03 585 1401	03.74		
21 03 321 6420	03.33	21 03 415 5404	03.21	21 03 485 3457	03.75	21 03 585 1401	03.76	21 04 416 1501	05.07
21 03 321 6510	03.33	21 03 415 5404	03.23	21 03 485 3457	03.76	21 03 585 1403	03.74	21 04 416 1501	05.09
21 03 321 6520	03.33	21 03 415 5405	03.21			21 03 585 1403	03.76	21 04 416 1502	05.07
21 03 321 9400	03.36	21 03 415 5405	03.23	21 03 514 1801	03.22	21 03 585 1405	03.74	21 04 416 1502	05.09
		21 03 415 7401	03.21	21 03 514 1801	03.25	21 03 585 1405	03.76	21 04 416 1502	05.09
21 03 330 1300	03.54	21 03 415 7401	03.23	21 03 514 1803	03.22	21 03 585 1410	03.74	21 04 416 1503	05.07
		21 03 415 7402	03.21	21 03 514 1803	03.25	21 03 585 1410	03.76	21 04 416 1503	05.09
21 03 339 1301	03.54	21 03 415 7402	03.23	21 03 514 1805	03.22	21 03 585 1420	03.74	21 04 416 1504	05.07
21 03 339 2301	03.55	21 03 415 7403	03.21	21 03 514 1805	03.25	21 03 585 1420	03.76	21 04 416 1504	05.09
		21 03 415 7403	03.23			21 03 585 1451	03.74	21 04 416 1505	05.07
		21 03 415 7404	03.21			21 03 585 1451	03.76	21 04 416 1505	05.09
21 03 341 1425	03.50	21 03 415 7404	03.23	21 03 515 4401	03.21	21 03 585 1457	03.74	21 04 416 1505	05.09
21 03 341 1505	03.56	21 03 415 7405	03.21	21 03 515 4401	03.24	21 03 585 1457	03.76	21 04 416 3501	05.07
21 03 341 1518	03.58	21 03 415 7405	03.23	21 03 515 4402	03.21	21 03 585 1457	03.76	21 04 416 3501	05.09
21 03 341 2425	03.51			21 03 515 4402	03.24	21 03 585 1457	03.76	21 04 416 3502	05.07
21 03 341 2505	03.57	21 03 449 4301	03.47	21 03 515 4402	03.24	21 03 585 1457	03.76	21 04 416 3502	05.09
21 03 341 2518	03.59	21 03 449 4302	03.47	21 03 515 4403	03.21	21 03 585 1457	03.76	21 04 416 3502	05.09
21 03 341 6401	03.62	21 03 449 4302	03.49	21 03 515 4403	03.24	21 03 585 1457	03.76	21 04 416 3502	05.09
		21 03 449 4302	03.49	21 03 515 4404	03.21	21 03 585 1457	03.76	21 04 416 3503	05.07
21 03 371 1400	03.86	21 03 449 4303	03.47	21 03 515 4404	03.24	21 03 585 1457	03.76	21 04 416 3503	05.09
21 03 371 1403	03.82	21 03 449 4303	03.49	21 03 515 4405	03.21	21 03 585 1457	03.76	21 04 416 3503	05.09
21 03 371 1420	03.84	21 03 449 4304	03.47	21 03 515 4405	03.24	21 03 585 1457	03.76	21 04 416 3504	05.07
21 03 371 2403	03.83	21 03 449 4304	03.49	21 03 515 4405	03.24	21 03 585 1457	03.76	21 04 416 3504	05.09
21 03 371 2415	03.87	21 03 449 4305	03.47	21 03 515 7401	03.21	21 03 585 1457	03.76	21 04 416 3504	05.09
		21 03 449 4305	03.49	21 03 515 7401	03.24	21 03 585 1457	03.76	21 04 416 3505	05.07
		21 03 449 6301	03.47	21 03 515 7402	03.21	21 03 585 1457	03.76	21 04 416 3505	05.09
21 03 381 1418	03.89	21 03 449 6301	03.49	21 03 515 7402	03.24	21 03 585 1457	03.76	21 04 516 1402	05.08
21 03 381 1425	03.78	21 03 449 6302	03.47	21 03 515 7403	03.21	21 03 585 1457	03.76	21 04 516 2302	05.08
21 03 381 2400	03.84	21 03 449 6302	03.49	21 03 515 7403	03.24	21 03 585 1457	03.76	21 04 516 2302	05.08
21 03 381 2401	03.84	21 03 449 6303	03.47	21 03 515 7404	03.21	21 03 585 1457	03.76	21 04 516 2501	05.07
21 03 381 2418	03.90	21 03 449 6303	03.49	21 03 515 7404	03.24	21 03 585 1457	03.76	21 04 516 2501	05.09
21 03 381 2425	03.79	21 03 449 6303	03.47	21 03 515 7405	03.21	21 03 585 1457	03.76	21 04 516 2502	05.07
21 03 381 2800	04.07	21 03 449 6304	03.47	21 03 515 7405	03.24	21 03 585 1457	03.76	21 04 516 2502	05.09
21 03 381 2801	04.12	21 03 449 6304	03.49	21 03 515 7405	03.24	21 03 812 1405	03.16	21 04 516 2502	05.09
21 03 381 2802	04.09	21 03 449 6305	03.47			21 03 812 1505	03.16	21 04 516 2503	05.07
21 03 381 2803	04.09	21 03 449 6305	03.49	21 03 549 1301	03.47	21 03 812 2405	03.18	21 04 516 2503	05.09
21 03 381 2804	04.10			21 03 549 1302	03.48	21 03 812 2505	03.18	21 04 516 2504	05.07
21 03 381 2805	04.10	21 03 483 1801	04.06	21 03 549 1303	03.47			21 04 516 2504	05.09
21 03 381 2806	04.11	21 03 483 1803	04.06	21 03 549 1303	03.48	21 03 821 1505	03.16	21 04 516 2505	05.07
21 03 381 2807	04.11	21 03 483 1805	04.06	21 03 549 1304	03.47			21 04 516 2505	05.09
21 03 381 2809	04.10	21 03 483 1807	04.06	21 03 549 1304	03.48			21 04 516 2505	05.09
21 03 381 4400	03.84	21 03 483 1810	04.06	21 03 549 1305	03.47			21 04 516 4501	05.07
21 03 381 4401	03.84	21 03 483 5801	04.06	21 03 549 1305	03.48			21 04 516 4501	05.09
21 03 381 4410	03.88	21 03 483 5802	04.06	21 03 549 1305	03.48	21 03 822 1425	03.28	21 04 516 4502	05.07
21 03 381 4411	03.88	21 03 483 5850	04.06	21 03 549 2301	03.47	21 03 822 1525	03.28	21 04 516 4502	05.09
21 03 381 4412	03.88	21 03 483 5851	04.06	21 03 549 2301	03.49	21 03 822 2425	03.29	21 04 516 4503	05.07
21 03 381 4413	03.88	21 03 483 5852	04.06	21 03 549 2302	03.47	21 03 822 2525	03.29	21 04 516 4503	05.09
21 03 381 4430	03.88			21 03 549 2302	03.49	21 03 822 2535	07.04	21 04 516 4503	05.09
21 03 381 4432	03.88			21 03 549 2303	03.47	21 03 822 2535	07.04	21 04 516 4504	05.07
21 03 381 4800	04.07	21 03 485 1401	03.74	21 03 549 2303	03.49	21 03 822 3505	03.17	21 04 516 4504	05.09
21 03 381 4802	04.09	21 03 485 1401	03.76	21 03 549 2304	03.47	21 03 822 4505	03.19	21 04 516 4505	05.07
21 03 381 4804	04.10	21 03 485 1403	03.74	21 03 549 2304	03.49			21 04 516 4505	05.09
21 03 381 6401	03.85	21 03 485 1403	03.76	21 03 549 2305	03.47				
21 03 381 6405	03.85	21 03 485 1405	03.74	21 03 549 2305	03.49	21 03 841 1505	03.44		
21 03 381 6410	03.87	21 03 485 1405	03.76	21 03 549 3301	03.47	21 03 841 1525	03.52		
21 03 381 6420	03.87	21 03 485 1410	03.74	21 03 549 3302	03.47	21 03 841 1535	07.05		
21 03 381 6815	04.08	21 03 485 1410	03.76	21 03 549 3302	03.48	21 03 841 2505	03.45		
		21 03 485 1420	03.74	21 03 549 3303	03.47	21 03 841 2525	03.53		
		21 03 485 1420	03.76	21 03 549 3303	03.48			21 83 515 4401	03.21
21 03 415 2401	03.21	21 03 485 1451	03.74	21 03 549 3304	03.47	21 03 881 1405	03.69	21 83 515 4401	03.25
21 03 415 2401	03.23	21 03 485 1451	03.76	21 03 549 3304	03.48	21 03 881 1805	04.05	21 83 515 4402	03.21
21 03 415 2402	03.21	21 03 485 1457	03.74	21 03 549 3305	03.47	21 03 881 5805	04.05	21 83 515 4402	03.25
21 03 415 2402	03.23	21 03 485 1457	03.76	21 03 549 3305	03.48			21 83 515 4403	03.21
21 03 415 2403	03.21	21 03 485 3401	03.75	21 03 549 3305	03.48			21 83 515 4403	03.25
21 03 415 2403	03.23	21 03 485 3401	03.76	21 03 549 4301	03.47			21 83 515 4403	03.25
21 03 415 2404	03.21	21 03 485 3403	03.75	21 03 549 4301	03.49			21 83 515 4404	03.21
21 03 415 2404	03.23	21 03 485 3403	03.76	21 03 549 4302	03.47			21 83 515 4404	03.25
21 03 415 2405	03.21	21 03 485 3405	03.75	21 03 549 4302	03.48	21 03 882 1405	03.68	21 83 515 4404	03.25
21 03 415 2405	03.23	21 03 485 3405	03.76	21 03 549 4303	03.47	21 03 882 1415	03.68	21 83 515 4405	03.21
21 03 415 5401	03.21	21 03 485 3410	03.75	21 03 549 4303	03.49	21 03 882 1425	03.80	21 83 515 4405	03.25
				21 03 549 4304	03.47	21 03 882 1435	07.05	21 83 515 7401	03.21
						21 03 882 2405	03.70	21 83 515 7401	03.25
						21 03 882 2425	03.81	21 83 515 7402	03.21
						21 03 882 3405	03.69	21 83 515 7402	03.25
								21 83 515 7403	03.21
								21 83 515 7403	03.25
								21 83 515 7404	03.21
								21 83 515 7404	03.25
								21 83 515 7404	03.25
								21 83 515 7405	03.21
						21 04 116 1505	05.04	21 83 515 7405	03.21
						21 04 116 2505	05.05	21 83 515 7405	03.25

Be

Please send me further information:



Interface Connectors



Device Connectivity



Industrial Connectors Han®

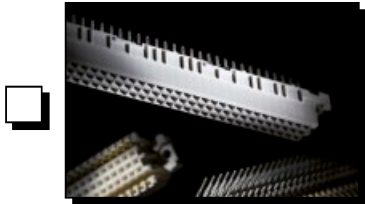

**Connectors
DIN 41 612**



**Intelligent Network
Solutions**



**Coaxial and Metric
Connectors**



**Application
brochure**

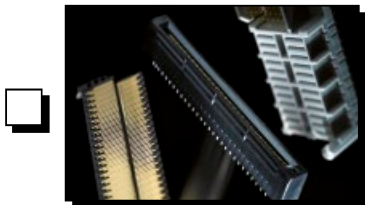

TCA Connectors

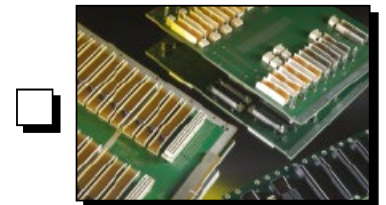

**High Speed
Backplanes**

Sender:

Company: _____

Street: _____

Department: _____

Postcode/Town: _____

Name: _____

Country: _____

Prenome: _____

Phone: _____

Function: _____

Fax: _____

E-Mail: _____

Please send it by post or fax to your local HARTING representatives (see page addresses) or visit us under www.HARTING.com.

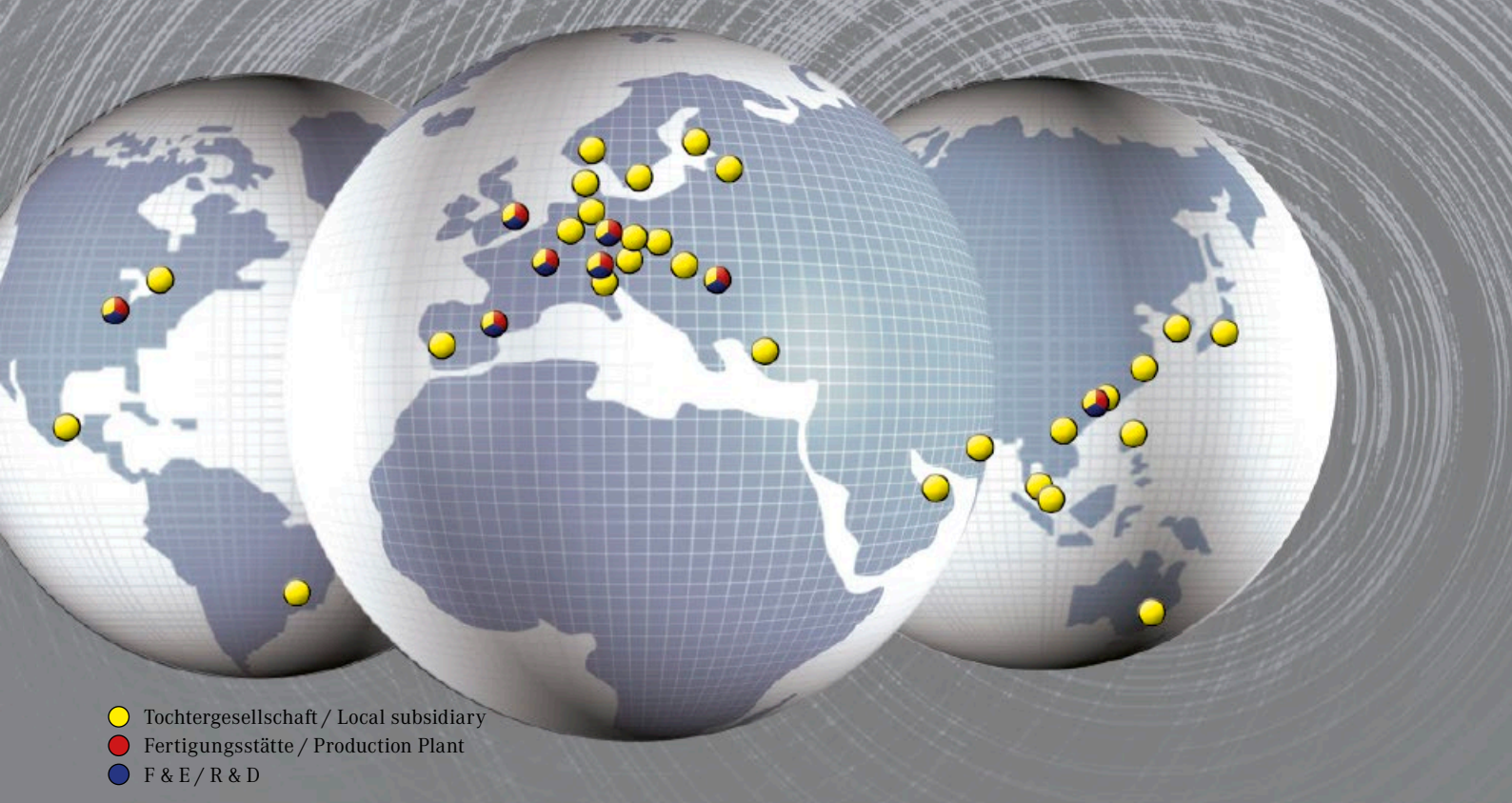

- Tochtergesellschaft / Local subsidiary
- Fertigungsstätte / Production Plant
- F & E / R & D

Sales Network – worldwide



Afghanistan

see United Arab Emirates

Albania

see Eastern Europe

Argentina

Condelectric S.A.
Hipólito Yrigoyen 2591, 1640 - Martínez
Buenos Aires – Argentina
Phone +54 11 4836 1053
Fax +54 11 4836 1053
comercial@condelectric.com.ar

Armenia

see Eastern Europe

Australia

HARTING Pty Ltd
Suite 11 / 2 Enterprise Drive
Bundoora 3083, AUS-Victoria
Phone +61 3 9466 7088
Fax +61 3 9466 7099
au@HARTING.com
www.HARTING.com.au

Austria

HARTING Ges.m.b.H.
Deutschstraße 19, A-1230 Wien
Phone +431 6162121
Fax +431 6162121-21
at@HARTING.com
www.HARTING.at

Azerbaijan

see Eastern Europe

Bahrain

see United Arab Emirates

Belgium

HARTING N.V./S.A.
Z.3 Doornveld 23, B-1731 Zellik
Phone +32 2 466 0190
Fax +32 2 466 7855
be@HARTING.com
www.HARTING.be

Bosnia and Herzegovina

see Eastern Europe

Brazil

HARTING Ltda.
Rua Major Paladino 128 –
Prédio 11
CEP 05307-000 – São Paulo –
SP – Brasil
Phone +55 11 5035 0073
Fax +55 11 5034 4743
br@HARTING.com
www.HARTING.com.br

Brunei

see Singapore

Bulgaria

see Eastern Europe

Canada

HARTING Canada Inc.
8455 Trans-Canada Hwy., Suite 202
St. Laurent, QC, H4S1Z1, Canada
Phone 855-659-6653
Fax 855-659-6654
info.ca@HARTING.com
www.HARTING.ca

China

HARTING (Zhuhai)
Manufacturing Co., Ltd.
Shanghai Branch, Room 3501- 3503,
No. 1, Hong Qiao Road, Grand Gateway I
Xu Hui District, Shanghai 200030, China
Phone +86 21 6386 2200
Fax +86 21 6386 8636
cn@HARTING.com
www.HARTING.com.cn

Croatia

see Eastern Europe

Czech Republic

HARTING s.r.o.
Mlýnská 2, CZ-160 00 Praha 6
Phone +420 220 380 460
Fax +420 220 380 461
cz@HARTING.com
www.HARTING.cz

Denmark

HARTING ApS
Hjulgagervej 4a
DK - 7100 Vejle
Phone +45 70 25 00 32
Fax +45 75 80 64 99
dk@HARTING.com
www.HARTING.dk

Eastern Europe

HARTING Eastern Europe GmbH
Bamberger Straße 7
D-01187 Dresden
Phone +49 351 4361 760
Fax +49 351 436 1770
Eastern.Europe@HARTING.com
www.HARTING.com

Egypt

see United Arab Emirates

Estonia

see Eastern Europe

Finland

HARTING Oy
Teknobulevardi 3-5
FI-01530 Vantaa
Phone +358 207 291 510
Fax +358 207 291 511
fi@HARTING.com
www.HARTING.fi

France

HARTING France
181 avenue des Nations, Paris Nord 2
BP 66058 Tremblay en France
F-95972 Roissy Charles de Gaulle Cédex
Phone +33 1 4938 3400
Fax +33 1 4863 2306
fr@HARTING.com
www.HARTING.fr

Germany

HARTING Deutschland GmbH & Co. KG
P.O. Box 2451, D-32381 Minden
Simeons carré 1, D-32427 Minden
Phone +49 571 8896 0
Fax +49 571 8896 282
de@HARTING.com
www.HARTING.de

Georgia

see Eastern Europe

Great Britain

HARTING Ltd., Caswell Road
Brackmills Industrial Estate
GB-Northampton, NN4 7PW
Phone +44 1604 827 500
Fax +44 1604 706 777
gb@HARTING.com
www.HARTING.co.uk

Hong Kong

HARTING (HK) Limited
Regional Office Asia Pacific
3512 Metroplaza Tower 1
223 Hing Fong Road
Kwai Fong, N. T., Hong Kong
Phone +852 2423 7338
Fax +852 2480 4378
ap@HARTING.com
www.HARTING.com.hk

Hungary

HARTING Magyarország Kft.
Fehérvári út 89-95, H-1119 Budapest
Phone +36 1 205 34 64
Fax +36 1 205 34 65
hu@HARTING.com
www.HARTING.hu

India

HARTING India Pvt Ltd
7th Floor (West Wing), Central Square II
Unit No.B-19 Part, B 20&21
TVK Industrial Estate
Guindy, Chennai - 600032
Phone +91-44-43560415
+91-44-43456262
Fax +91-44-43560417
in@HARTING.com
http://www.HARTING.in

Indonesia

see Malaysia

Iran

see United Arab Emirates

Iraq

see United Arab Emirates

Israel

COMTEL
Israel Electronic Solutions Ltd.
Bet Hapamon, 20 Hataas st.
P.O.Box 66
Kefar-Saba 44425
Phone +972-9-7677240
Fax +972-9-7677243
sales@comtel.co.il
www.comtel.co.il

Italy

HARTING SpA
Via Dell' Industria 7
I-20090 Vimodrone (Milano)
Phone +39 02 250801
Fax +39 02 2650 597
it@HARTING.com
www.HARTING.it

Japan

HARTING K. K.
Yusen Shin-Yokohama 1 Chome Bldg., 2F
1-7-9, Shin-Yokohama, Kohoku
Yokohama 222-0033 Japan
Phone +81 45 476 3456
Fax +81 45 476 3466
jp@HARTING.com
www.HARTING.co.jp

Jemen

see United Arab Emirates

Jordan

see United Arab Emirates

Kazakhstan

see Eastern Europe

Kirghizia

see Eastern Europe

Korea (South)

HARTING Korea Limited
#308 Yatap Leaders Building
342-1, Yatap-dong, Bundang-gu
Sungnam-City, Kyunggi-do
463-828, Republic of Korea
Phone +82 31 781 4615
Fax +82 31 781 4616
kr@HARTING.com
www.HARTING.co.kr

Kosovo

see Eastern Europe

Kuwait

see United Arab Emirates

Latvia

see Eastern Europe

Lebanon

see United Arab Emirates

Lithuania

see Eastern Europe

Macedonia

see Eastern Europe

Malaysia (Office)

HARTING Singapore Pte Ltd
Malaysia Branch
11-02 Menara Amcorp
Jln. Persiaran Barat
46200 PJ, Sel. D. E., Malaysia
Phone +60 3 / 7955 6173
Fax +60 3 / 7955 5126
sg@HARTING.com

Montenegro

see Eastern Europe

Netherlands

HARTING B.V.
Larenweg 44
NL-5234 KA ,s-Hertogenbosch
Postbus 3526
NL-5203 DM ,s-Hertogenbosch
Phone +31 736 410 404
Fax +31 736 440 699
nl@HARTING.com
www.HARTINGbv.nl

New Zealand

see Australia

Norway

HARTING A/S
Østensjøveien 36, N-0667 Oslo
Phone +47 22 700 555
Fax +47 22 700 570
no@HARTING.com
www.HARTING.no

Oman

see United Arab Emirates

Pakistan

see United Arab Emirates

Philippines

see Malaysia

Poland

HARTING Polska Sp. z o. o.
ul. Duńska 9
PL- 54-427 Wrocław
Phone +48 71 352 81 71
Fax +48 71 350 42 13
pl@HARTING.com
www.HARTING.pl

Portugal

HARTING Iberia, S. A.
Avda. Josep Tarradellas 20-30 4º 6a
E-08029 Barcelona
Phone +351 219 673 177
Fax +351 219 678 457
es@HARTING.com
www.HARTING.es/pt

Qatar

see United Arab Emirates

Republic of Moldova

see Eastern Europe

Romania

HARTING Romania SCS
Europa Unita str. 21
550018-Sibiu, Romania
Phone +40 369-102 671
Fax +40 369-102 622
ro@HARTING.com
www.HARTING.com

Russia

HARTING ZAO
Maliy Sampsoniyevsky prospect 2A
194044 Saint Petersburg, Russia
Phone +7 812 327 6477
Fax +7 812 327 6478
ru@HARTING.com
www.HARTING.ru

Saudi Arabia

see United Arab Emirates

Serbia

see Eastern Europe

Singapore

HARTING Singapore Pte Ltd.
25 International Business Park
#04-108 German Centre
Singapore 609916
Phone +65 6225 5285
Fax +65 6225 9947
sg@HARTING.com
www.HARTING.sg

Slovakia

HARTING s.r.o.
Sales office Slovakia
J. Simora 5, SK - 940 52 Nové Zámky
Phone +421 356-493 993
Fax +421 356-402 114
sk@HARTING.com
www.HARTING.sk

Slovenia

see Eastern Europe

South Africa

HARTING South Africa (Pty) Ltd
Ground Floor, Twickenham Building
PO Box 67302
Johannesburg (Bryanston)
2021, South Africa
Phone +27 (0) 11 575 0017
Fax +27 (0) 11 576 6000
za@HARTING.com
www.HARTING.co.za

Spain

HARTING Iberia S.A.
Avda. Josep Tarradellas 20-30 4º 6a
E-08029 Barcelona
Phone +34 93 363 84 75
Fax +34 93 419 95 85
es@HARTING.com
www.HARTING.es

Sweden

HARTING AB
Gustavslundsvägen 141 B 4tr
S-167 51 Bromma
Phone +46 8 445 7171
Fax +46 8 445 7170
se@HARTING.com
www.HARTING.se

Switzerland

HARTING AG
Industriestrasse 26
CH-8604 Volketswil
Phone +41 44 908 20 60
Fax +41 44 908 20 69
ch@HARTING.com
www.HARTING.ch

Syria

see United Arab Emirates

Taiwan

HARTING Taiwan Ltd.
Room 1, 5/F
495 GuangFu South Road
RC-110 Taipei, Taiwan
Phone +886 2 2758 6177
Fax +886 2 2758 7177
tw@HARTING.com
www.HARTING.com.tw

Tajikistan

see Eastern Europe

Thailand

see Malaysia

Turkey

HARTING TURKEI Elektronik Ltd. Şti.
Barbaros Mah. Dereboyu Cad.
Fesleğen Sok.
Uphill Towers, A-1b Kat:8 D:45
34746 Ataşehir, İstanbul
Phone +90 216 688 81 00
Fax +90 216 688 81 01
tr@HARTING.com
www.HARTING.com.tr

Turkmenistan

see Eastern Europe

Ukraine

see Eastern Europe

United Arab Emirates

HARTING Middle East FZ-LLC
Knowledge Village, Block 2A, Office F72
P.O. Box 454372, Dubai
United Arab Emirates
Phone +971 4 453 9737
Fax +971 4 439 0339
uae@HARTING.com
www.HARTING.ae

USA

HARTING Inc. of North America
1370 Bowes Road
USA-Elgin, Illinois 60123
Phone +1 (877) 741-1500 (toll free)
Fax +1 (866) 278-0307 (Inside Sales)
us@HARTING.com
www.HARTING-USA.com

Uzbekistan

see Eastern Europe

Vietnam

see Singapore

Distributors – worldwide



Digi-Key Corporation:
www.digikey.com

Farnell:
www.farnell.com

FUTURE Electronics:
www.futureelectronics.com

Mouser Electronics:
www.mouser.com

RS Components:
www.rs-components.com

Other countries and general contact



HARTING Electronics GmbH
P.O. Box 1433
32328 Espelkamp - Germany
Phone +49 5772/47-97200
Fax +49 5772/47-777
electronics@HARTING.com



Pushing Performance

HARTING.com –
the gateway to your
country website.

www.HARTING.ae
www.HARTING.at
www.HARTING.com.au
www.HARTING.be
www.HARTING.com.br
www.HARTING.ca
www.HARTING.ch
www.HARTING.com.cn
www.HARTING.cz
www.HARTING.de
www.HARTING.dk
www.HARTING.es
www.HARTING-easterneurope.com
www.HARTING.fi
www.HARTING.fr
www.HARTING.co.uk
www.HARTING.com.hk
www.HARTING.hu
www.HARTING.co.in
www.HARTING.it
www.HARTING.co.jp
www.HARTING.co.kr
www.HARTINGbv.nl
www.HARTING.no
www.HARTING.pl
www.HARTING.pt
www.HARTING.ro
www.HARTING.ru
www.HARTING.se
www.HARTING.sg
www.HARTING.sk
www.HARTING.com.tr
www.HARTING.com.tw
www.HARTING-USA.com
www.HARTING.co.za